

NM12-38

12V38Ah / 10hr rate



Introduction

Generagy NM (31Ah-250Ah) series is designed for standby use with 10-year design life in float service. The series battery is featured of high consistency, excellent performance and reliable standby service life. It is widely applied in float service, UPS/EPS, medical equipment, telecom, photovoltaic, control system and security system.

Battery Features

- Increase durability and deep cycle ability for heavy demand applications
- Low self-discharge
- Fully tank formed plates
- Low impurity electrolyte
- Spill proof / leak proof
- Multi-position usage
- ABS case and cover VO upon request
- Very high purity lead

Electrical Specification

| | |
|--|--------------|
| Design floating Life @ 25°C (77°F) | 10 years |
| Nominal Capacity @ 25°C /77°F | |
| 20 hour rate 2 A to 1.75Vpc | 40 Ah |
| 10 hour rate 3.9 A to 1.75Vpc | 39 Ah |
| Internal Resistance | |
| (Fully charged battery @ 25°C /77°F) | 10mΩ |
| Max. Discharge Current @ 25°C /77°F | 380 A (5S) |
| Charge Methods: Constant voltage charge @ 25°C /77°F | |
| Cycle Use | 14.7 ~ 14.9V |
| Max. Current | 9.5 A |
| Standby Use | 13.6 - 13.8V |
| Operating Temperature Range | -30 ~ 50°C |
| <i>Notes: battery voltage must be adjusted according to temperature. Please refer to our recommendation.</i> | |
| Self-Discharge | |
| 3% of capacity declined per month @ 25°C (77°F). | |

Battery Picture & Terminal Layout

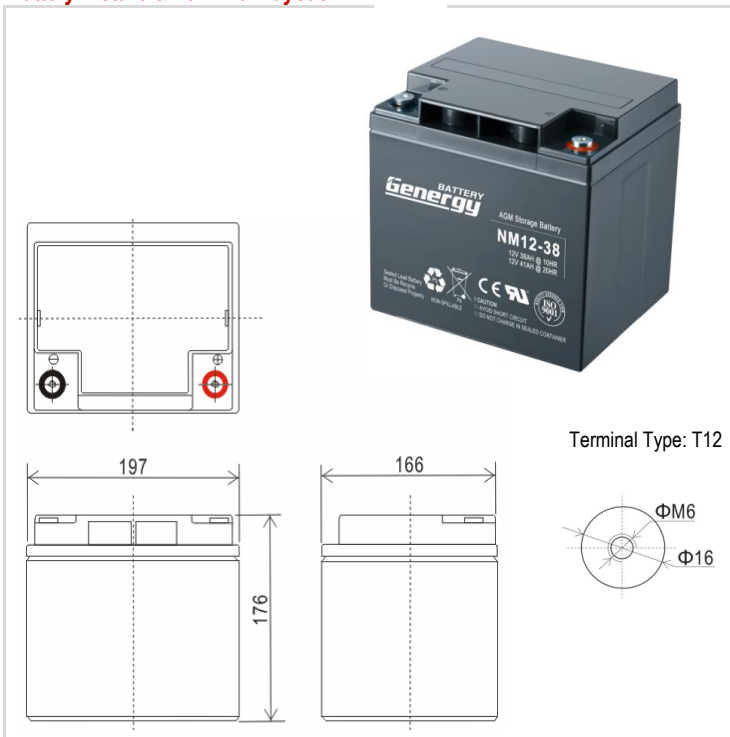

Dimension & Weight

| Length | Dimension (± 2mm) | | | Total Height | Weight (± 2%) |
|----------|-------------------|----------|--------------|--------------|---------------|
| | Width | Height | Total Height | | |
| 197 mm | 166 mm | 176 mm | 176 mm | 12.3 kg | |
| 7.8 inch | 6.5 inch | 6.9 inch | 6.9 inch | 27.0 lbs | |

Typical Applications

- UPS & EPS
- Telecommunications
- Power Utility
- Security Power Supply

Constant Current Discharge (Amperes @ 25°C /77°F)

| V/cell | 10min | 15min | 20min | 25min | 30min | 35min | 40min | 45min | 50min | 55min | 1hr | 2hr | 3hr | 4hr | 5hr | 10hr | 20hr |
|--------|-------|-------|-------|-------|-------|-------|-------|-------|-------|-------|-------|-------|-------|------|------|------|------|
| 1.60 | 94.16 | 71.88 | 62.09 | 52.31 | 44.28 | 39.84 | 37.15 | 34.46 | 32.22 | 30.28 | 28.79 | 15.61 | 11.11 | 9.22 | 7.54 | 4.03 | 2.04 |
| 1.65 | 89.41 | 68.25 | 59.28 | 50.31 | 43.09 | 38.78 | 36.23 | 33.67 | 31.56 | 29.76 | 28.40 | 15.31 | 10.89 | 9.03 | 7.37 | 4.01 | 2.04 |
| 1.70 | 85.72 | 65.44 | 56.94 | 48.45 | 41.70 | 37.50 | 35.04 | 32.59 | 30.58 | 28.88 | 27.62 | 14.79 | 10.64 | 8.82 | 7.19 | 3.97 | 2.04 |
| 1.75 | 81.76 | 62.42 | 54.40 | 46.39 | 40.12 | 36.08 | 33.79 | 31.50 | 29.66 | 28.12 | 27.03 | 14.38 | 10.41 | 8.63 | 7.04 | 3.93 | 2.02 |
| 1.80 | 77.54 | 59.19 | 51.73 | 44.26 | 38.54 | 34.63 | 32.48 | 30.32 | 28.61 | 27.21 | 26.25 | 13.87 | 10.16 | 8.41 | 6.87 | 3.83 | 2.00 |

Constant Power Discharge (Watts/cell @ 25°C /77°F)

| V/cell | 10min | 15min | 20min | 25min | 30min | 35min | 40min | 45min | 50min | 55min | 1hr | 2hr | 3hr | 4hr | 5hr | 10hr | 20hr |
|--------|--------|--------|--------|-------|-------|-------|-------|-------|-------|-------|-------|-------|-------|-------|-------|------|------|
| 1.60 | 163.53 | 124.83 | 109.86 | 94.88 | 82.71 | 74.61 | 69.30 | 64.00 | 59.50 | 55.70 | 52.49 | 28.86 | 21.00 | 17.42 | 14.35 | 8.04 | 4.24 |
| 1.65 | 157.73 | 120.40 | 106.18 | 91.96 | 80.53 | 72.63 | 67.53 | 62.43 | 58.12 | 54.52 | 51.52 | 28.27 | 20.81 | 17.23 | 14.16 | 7.96 | 4.24 |
| 1.70 | 151.66 | 115.77 | 102.23 | 88.70 | 77.96 | 70.33 | 65.49 | 60.65 | 56.61 | 53.28 | 50.54 | 27.59 | 20.42 | 16.93 | 13.94 | 7.81 | 4.18 |
| 1.75 | 145.07 | 110.74 | 97.96 | 85.17 | 75.19 | 67.82 | 63.25 | 58.68 | 54.91 | 51.84 | 49.37 | 26.71 | 19.84 | 16.52 | 13.69 | 7.75 | 4.11 |
| 1.80 | 137.94 | 105.30 | 93.34 | 81.38 | 72.23 | 65.12 | 60.82 | 56.51 | 53.01 | 50.20 | 48.00 | 25.77 | 19.32 | 16.10 | 13.38 | 7.67 | 4.07 |

Subject to revision without notice. Please contact our sales representatives for latest version.

Web: www.generagybattery.com | Email: sales@generagybattery.com

NM12-38

12V38Ah / 10hr rate



Graphs

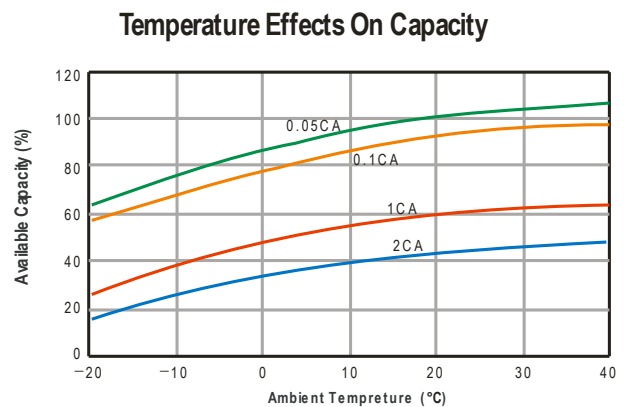
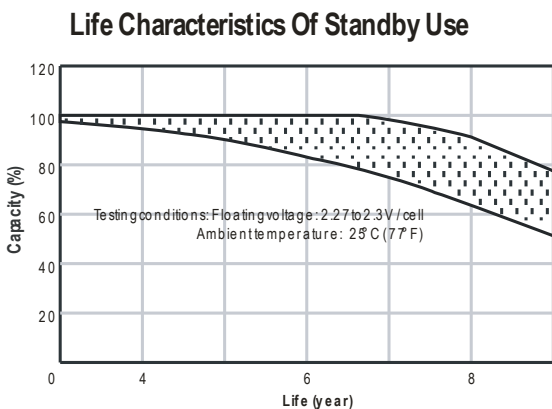
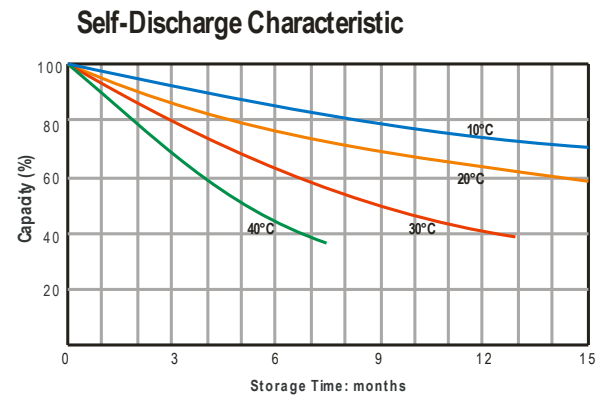
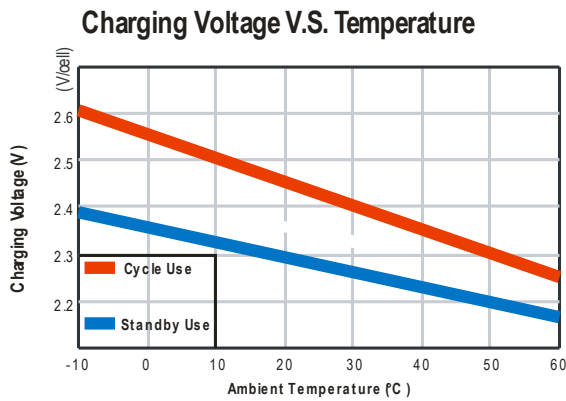
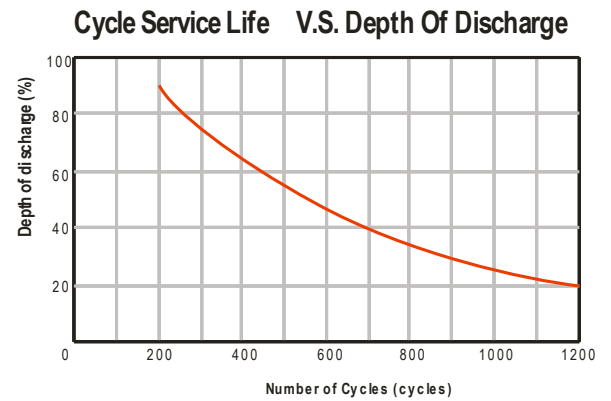
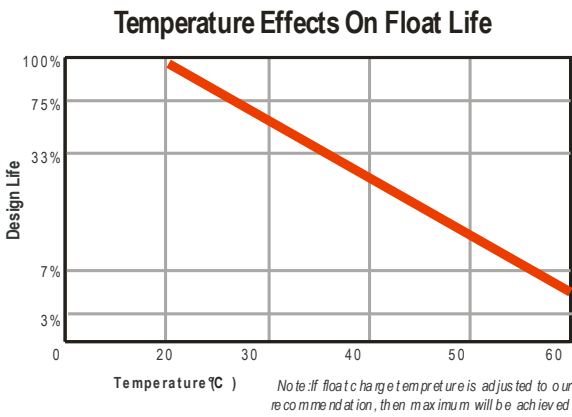
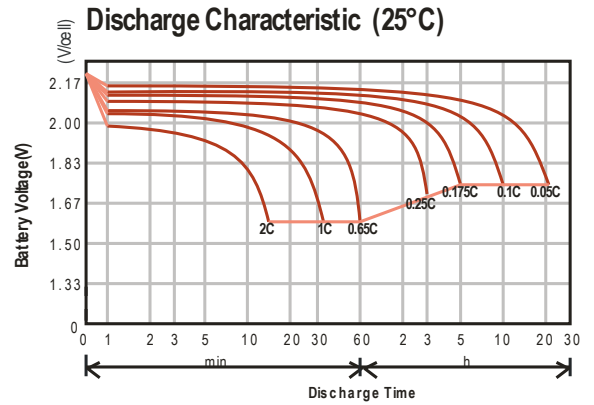
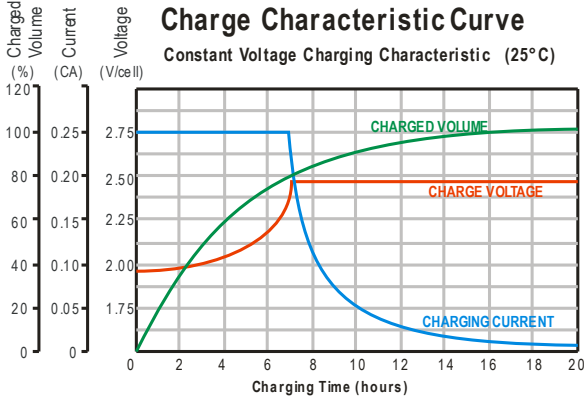

Subject to revision without notice. Please contact our sales representatives for latest version.

Web: www.genergybattery.com | Email: sales@genergybattery.com