

NL2-1000

2V1000Ah / 10hr rate



Introduction

Generagy NL (2V) series is designed for standby use with 15-year design life in float service. The series battery is featured of high consistency, excellent performance and reliable standby service life. It is widely applied in Telecoms, Power Utility, Renewables, UPS/EPS, and medical equipment.

Key Features

- Valve regulated maximum internal pressure 2.5 PSI
- Increase durability and deep cycle ability for heavy demand applications
- Low self-discharge
- Fully tank formed plates
- Low impurity electrolyte
- Spill proof / leak proof
- Multi-position usage
- ABS case and cover VO upon request
- Very high purity lead

Electrical Specification

Design floating Life @ 25°C (77°F)	15 years
Nominal Capacity @ 25°C /77°F	
20 hour rate 53.81A to 1.75Vp	1076 Ah
10 hour rate 102.57A to 1.75V	1020Ah
Internal Resistance	
(Fully charged battery @ 25°C /77°F)	0.5 mΩ
Max. Discharge Current @ 25°C /77°	2500 A (5S)
Charge Methods: Constant voltage charge @ 25°C /77°F	
Cycle Use	2.45 ~ 2.49V
Max. Curren	200 A
Standby Use	2.25 ~ 2.30V
Operating Temperature Range	-30 ~ 50°C
Notes: battery voltage must be adjusted according to temperature.	
Please refer to our recommendation.	
Self-Discharge	
3% of capacity declined per month @ 25°C (77°F).	

Battery Picture & Terminal Layout

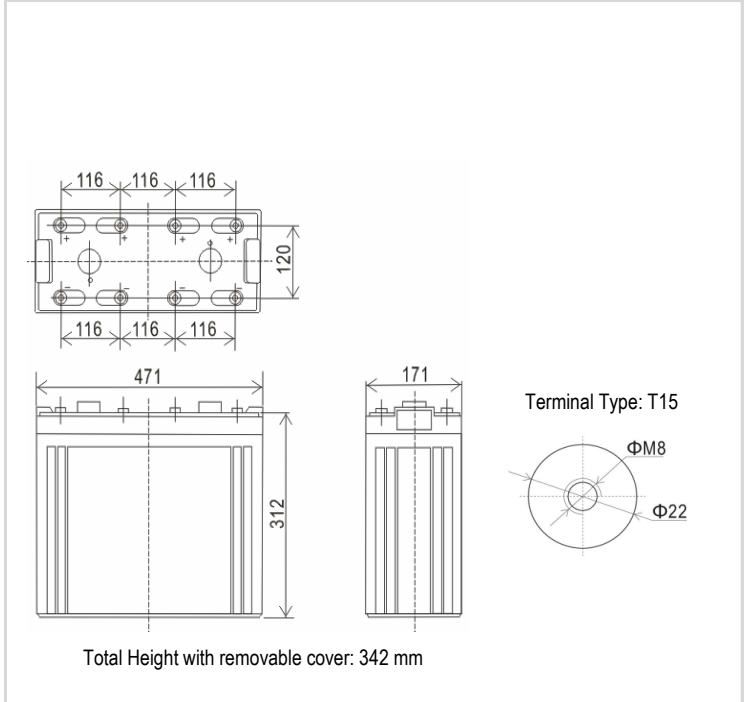

Dimension & Weight

	Dimension (± 2mm)			Total Height	Weight (± 2%)
	Length	Width	Height		
	471 mm	171 mm	312 mm	342 mm	62 kg
	18.5 inch	6.7 inch	12.3 inch	13.5 inch	136.7 lbs

Typical Applications

- Telecommunications
- UPS & EPS
- Power Utility
- Data Center
- Solar Energy System

Constant Current Discharge (Amperes @ 25°C /77°F)

V/cell	10min	15min	20min	25min	30min	35min	40min	45min	50min	55min	1hr	2hr	3hr	4hr	5hr	10hr	20hr
1.60	1949.6	1488.2	1337.4	1186.7	1042.1	965.2	894.6	824.0	765.8	720.7	682.6	386.38	292.09	246.36	201.02	107.62	56.33
1.65	1852.6	1414.2	1272.4	1130.6	995.0	922.4	855.9	789.5	732.5	687.7	650.7	363.67	283.68	240.47	197.66	105.94	55.49
1.70	1755.7	1340.2	1207.4	1074.5	947.9	879.2	816.7	754.2	701.1	660.2	627.2	349.98	275.27	234.58	194.30	104.26	54.65
1.75	1656.6	1264.6	1140.1	1015.7	897.5	833.0	774.7	716.4	667.5	630.8	602.0	335.31	263.50	226.18	189.25	102.58	53.81
1.80	1557.5	1188.9	1072.9	956.8	847.0	786.7	732.6	678.5	633.8	601.3	576.8	320.65	251.73	217.77	184.21	100.90	52.97

Constant Power Discharge (Watts/cell @ 25°C /77°F)

V/cell	10min	15min	20min	25min	30min	35min	40min	45min	50min	55min	1hr	2hr	3hr	4hr	5hr	10hr	20hr
1.60	3136.9	2394.6	2225.9	2057.2	1883.3	1772.7	1656.9	1541.2	1428.1	1332.8	1253.9	726.65	571.72	490.19	399.36	215.25	112.67
1.65	3026.8	2310.5	2138.4	1966.4	1789.2	1685.8	1577.3	1468.9	1363.1	1275.1	1203.5	697.32	556.58	480.10	394.32	211.88	110.99
1.70	2795.5	2134.0	1988.2	1842.5	1691.6	1595.8	1494.9	1394.1	1295.9	1215.4	1151.4	667.01	541.45	469.17	387.59	208.52	109.30
1.75	2623.7	2002.8	1868.3	1733.7	1594.1	1505.6	1412.0	1318.4	1227.5	1154.3	1097.6	635.73	524.63	457.40	380.86	205.16	107.62
1.80	2449.6	1869.9	1746.6	1623.3	1494.9	1413.4	1326.8	1240.2	1156.3	1090.1	1040.4	602.49	489.32	437.22	375.82	201.79	105.94

Subject to revision without notice. Please contact our sales representatives for latest version.

Web: www.generagybattery.com | Email: sales@generagybattery.com

NL2-1000

2V1000Ah / 10hr rate



Graphs

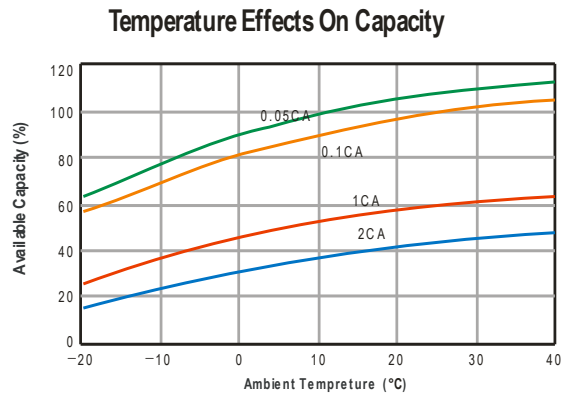
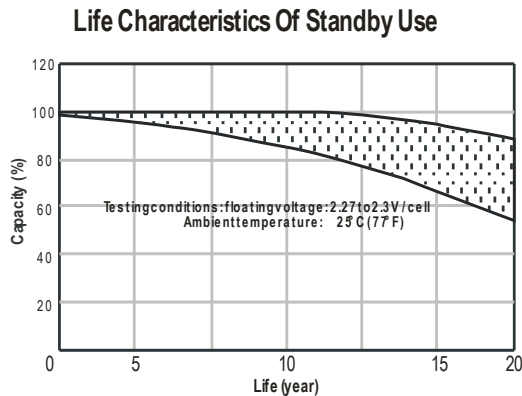
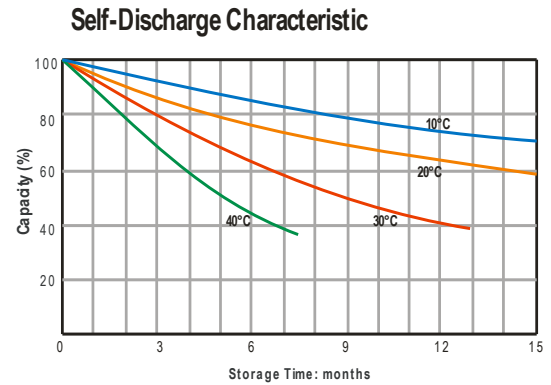
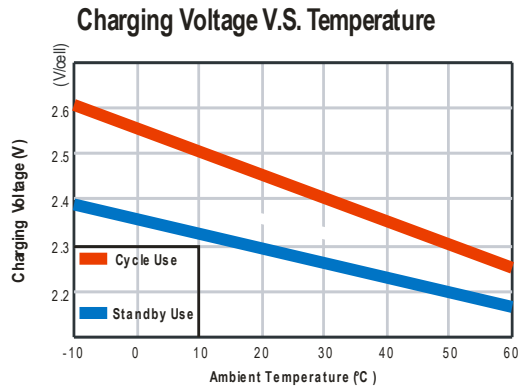
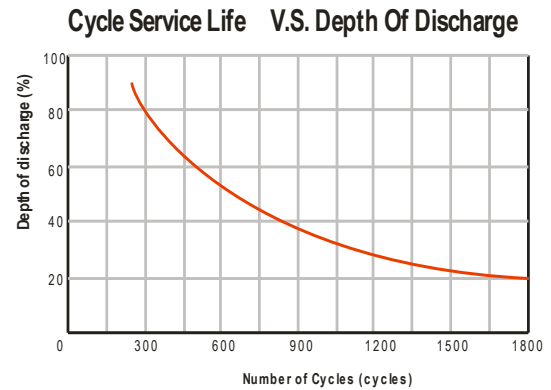
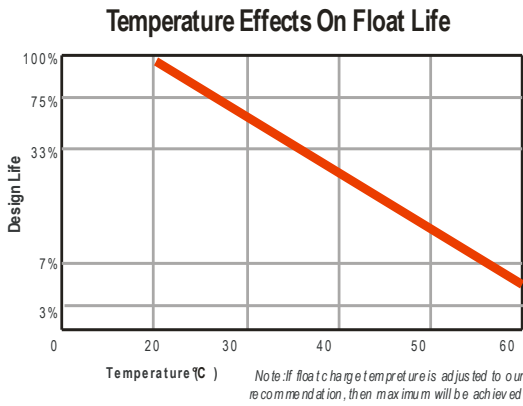
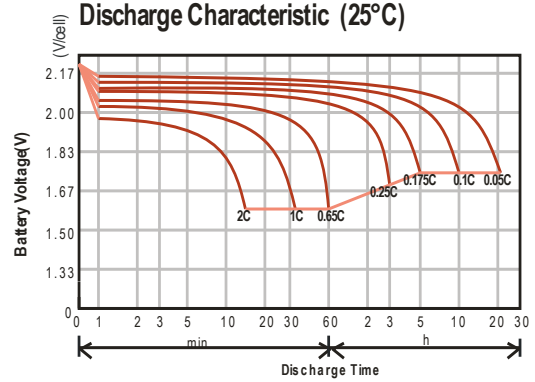
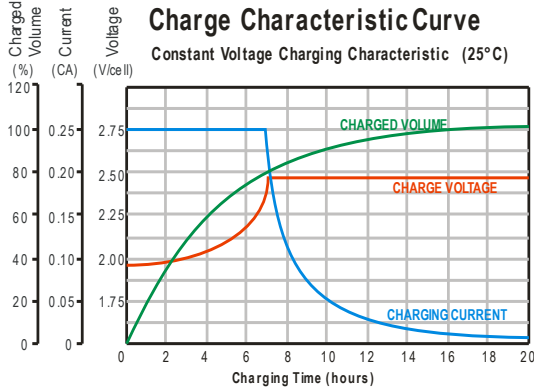

Subject to revision without notice. Please contact our sales representatives for latest version.

Web: www.genergybattery.com | Email: sales@genergybattery.com