

NH12-37W

12V37W / 15min



Introduction

Generagy NH (high rate) series is primarily for all critical power and UPS applications. Designed with a high-density plate technology, the series battery is featured of high consistency, excellent performance and reliable standby service life. It is widely applied in UPS/EPS, high power backup system and emergency power supply.

Battery Features

- High rate output aimed at the UPS market
- Low self-discharge
- Fully tank formed plates
- Low impurity electrolyte
- Spill proof / leak proof
- Multi-position usage
- ABS case and cover VO upon request
- Very high purity lead

Electrical Specification

Design floating Life @ 25°C (77°F)	5 years
Nominal Capacity @ 25°C /77°F	
Watt @ 15min to 1.67V/cell	37 W/cell
Watt @ 10min to 1.67V/cell	48 W/cell
Internal Resistance	
(Fully charged battery @ 25°C /77°F)	16mΩ
Max. Discharge Current @ 25°C /77°F	130A (5S)
Charge Methods: Constant voltage charge @ 25°C /77°F	
Cycle Use	14.7 ~ 14.9V
Max. Current	2.0A
Standby Use	13.6 ~ 13.8V
Operating Temperature Range	-30 ~ 50°C
<i>Notes: battery voltage must be adjusted according to temperature.</i>	
<i>Please refer to our recommendation.</i>	
Self-Discharge	3% of capacity declined per month @ 25°C (77°F).

Typical Applications

- UPS/EPS (High rate)
- High power backup supply
- Emergency power supply
- Emergency lighting
- Electric starting

Certificates



Battery Picture & Terminal Layout

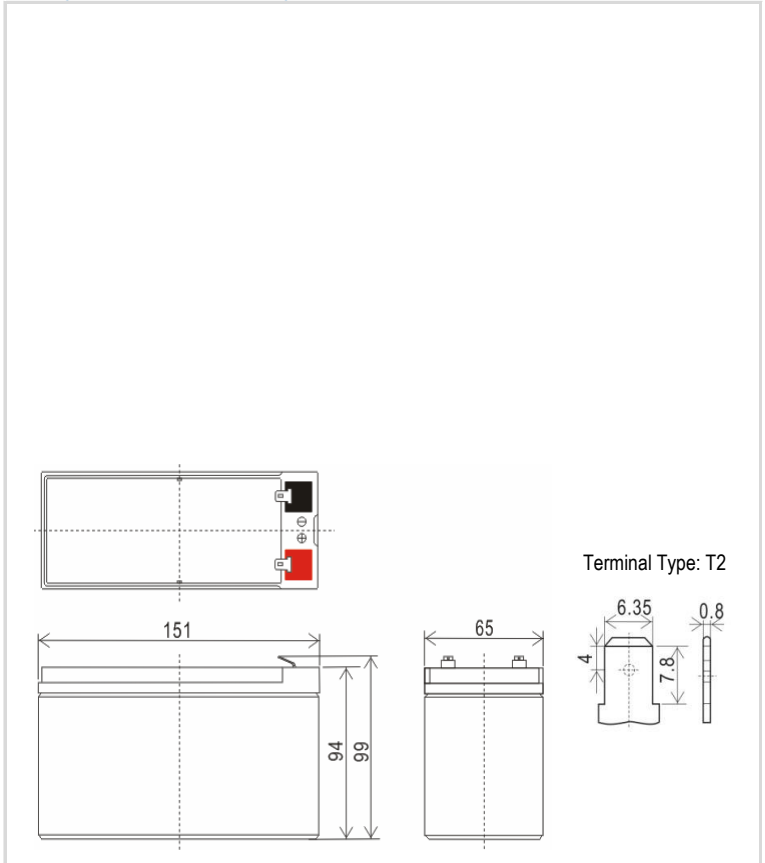

Dimension & Weight

	Dimension (± 2mm)			Total Height	Weight (± 2%)
	Length	Width	Height		
	151 mm	65 mm	94 mm	99 mm	2.50 kg
	5.9 inch	2.6 inch	3.7 inch	3.9 inch	5.5 lbs

Constant Current Discharge (Amperes @ 25°C /77°F)

V/cell	10min	15min	20min	30min	45min	55min	1hr	2hr	3hr
1.60	30.56	23.56	18.60	13.01	9.27	8.21	7.69	4.11	3.03
1.65	28.97	22.47	17.66	12.47	8.88	7.85	7.39	3.94	2.91
1.70	27.28	21.08	16.67	11.77	8.43	7.45	7.09	3.77	2.78
1.75	25.60	19.69	15.68	11.08	7.98	7.06	6.80	3.60	2.66
1.80	23.81	18.35	14.63	10.29	7.49	6.65	6.50	3.43	2.54

Constant Power Discharge (Watts/cell @ 25°C /77°F)

V/cell	10min	15min	20min	30min	45min	55min	1hr	2hr	3hr
1.60	50.7	39.3	30.9	24.06	17.39	15.61	14.67	7.79	5.69
1.65	49.0	37.9	29.7	23.00	16.66	15.02	14.28	7.57	5.53
1.67	48.3	37.2	29.2	22.42	16.33	14.74	14.09	7.46	5.45
1.70	47.3	36.4	28.5	21.94	15.89	14.39	13.85	7.32	5.35
1.75	45.4	35.0	27.3	20.87	15.12	13.75	13.41	7.07	5.17
1.80	43.2	33.3	25.8	19.72	14.30	13.07	12.93	6.80	4.98

NH12-37W

12V37W / 15min



Graphs

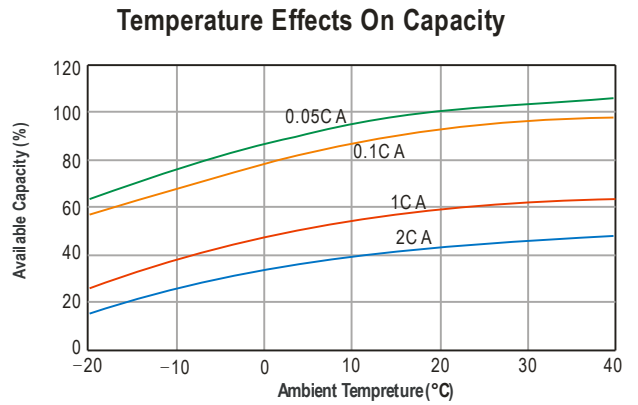
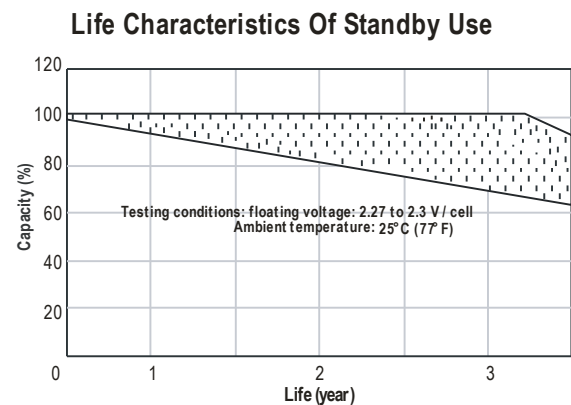
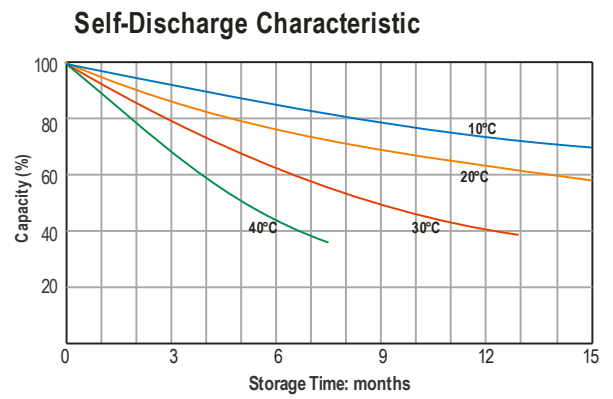
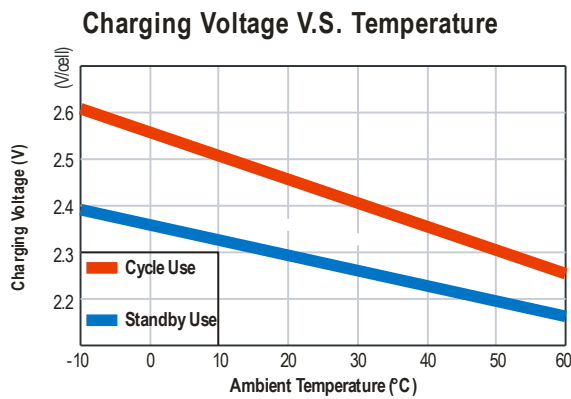
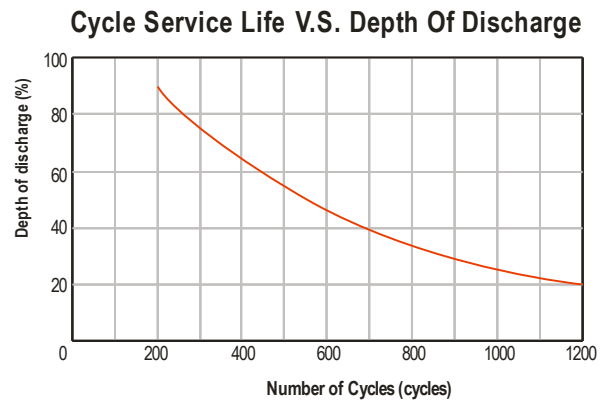
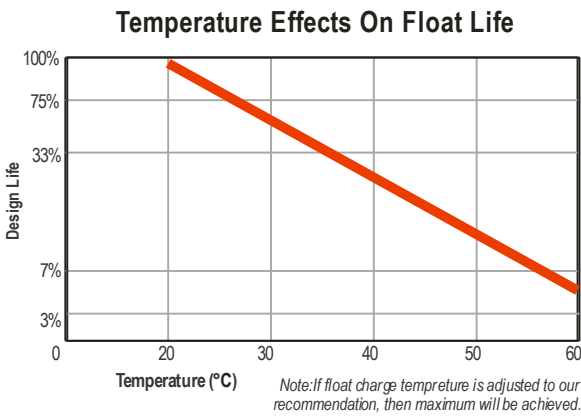
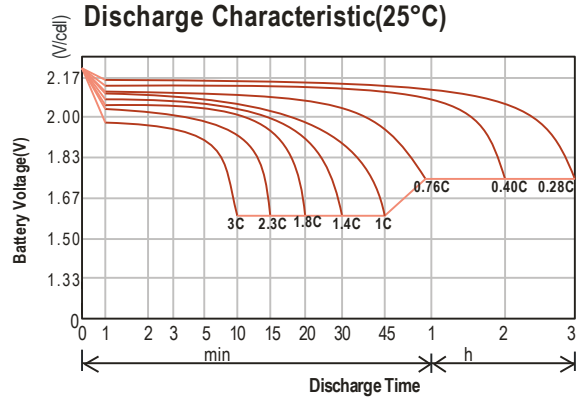
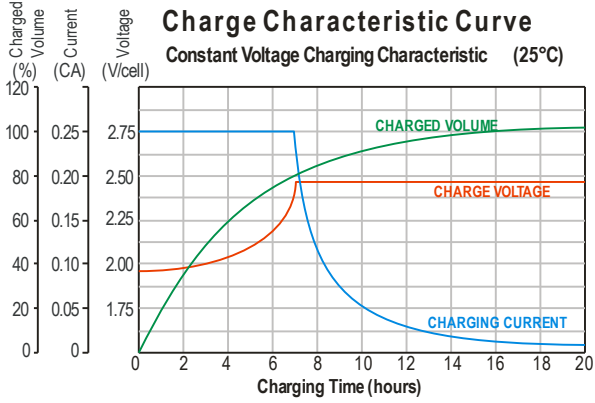

Subject to revision without notice. Please contact our sales representatives for latest version.

Web: www.generagybattery.com | Email: sales@generagybattery.com