

# NM12-40

12V40Ah / 10hr rate



## Introduction

**Generagy NM (31Ah-250Ah) series** is designed for standby use with 10-year design life in float service. The series battery is featured of high consistency, excellent performance and reliable standby service life. It is widely applied in float service, UPS/EPS, medical equipment, telecom, photovoltaic, control system and security system.

## Battery Features

- Increase durability and deep cycle ability for heavy demand applications
- Low self-discharge
- Fully tank formed plates
- Low impurity electrolyte
- Spill proof / leak proof
- Multi-position usage
- ABS case and cover VO upon request
- Very high purity lead

## Electrical Specification

Design floating Life @ 25°C (77°F)	10 years
Nominal Capacity @ 25°C /77°F	
20 hour rate 2.12A to 1.75Vpc	42.4 Ah
10 hour rate 4.14A to 1.75Vpc	41.4 Ah
Internal Resistance	
(Fully charged battery @ 25°C /77°F)	10mΩ
Max. Discharge Current @ 25°C /77°F	400 A (5S)
Charge Methods: Constant voltage charge @ 25°C /77°F	
Cycle Use	14.7 ~ 14.9V
Max. Current	10 A
Standby Use	13.6 - 13.8V
Operating Temperature Range	-30 ~ 50°C
<i>Notes: battery voltage must be adjusted according to temperature. Please refer to our recommendation.</i>	
Self-Discharge	
3% of capacity declined per month @ 25°C (77°F).	

## Battery Picture & Terminal Layout

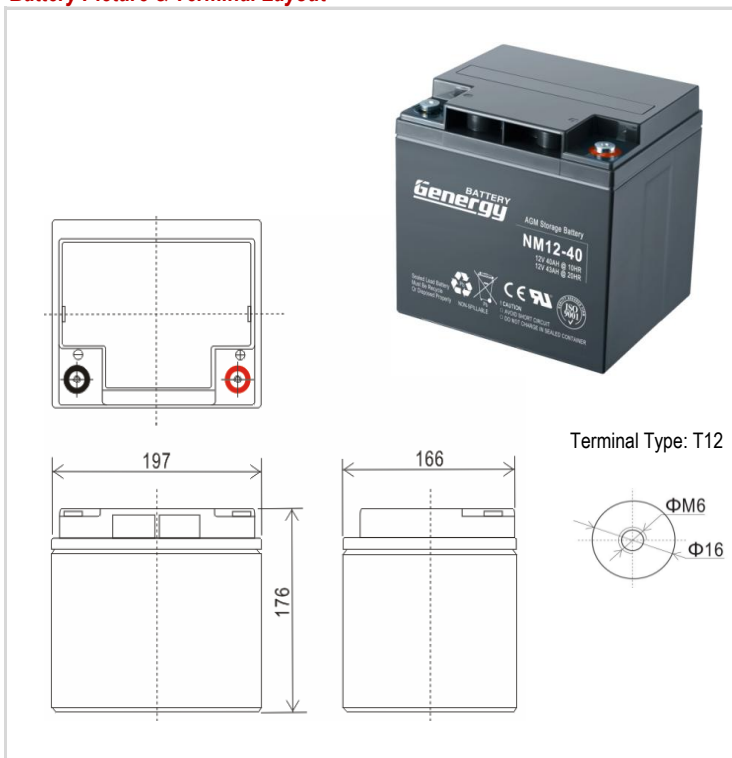

## Dimension & Weight

Length	Dimension (± 2mm)			Total Height	Weight (± 2%)
	Width	Height	Total Height		
197 mm	166 mm	176 mm	176 mm	12.6 kg	
7.8 inch	6.5 inch	6.9 inch	6.9 inch	27.7 lbs	

## Typical Applications

- Telecommunications
- Power Utility
- Data Center
- UPS & EPS

## Certificates



## Constant Current Discharge (Amperes @ 25°C /77°F)

V/cell	10min	15min	20min	25min	30min	35min	40min	45min	50min	55min	1hr	2hr	3hr	4hr	5hr	10hr	20hr
1.60	99.06	75.62	65.32	55.03	47.44	41.91	39.08	36.25	33.82	31.89	30.27	16.48	11.67	9.70	7.93	4.24	2.14
1.65	94.06	71.80	62.37	52.93	46.19	40.80	38.11	35.42	33.13	31.34	29.85	16.16	11.45	9.50	7.75	4.22	2.14
1.70	90.18	68.84	59.90	50.97	44.73	39.45	36.87	34.28	32.10	30.41	29.03	15.62	11.19	9.28	7.57	4.18	2.14
1.75	86.02	65.66	57.23	48.80	43.07	37.96	35.55	33.14	31.13	29.62	28.41	15.19	10.94	9.07	7.41	4.14	2.12
1.80	81.58	62.27	54.42	46.56	41.40	36.43	34.17	31.90	30.03	28.66	27.59	14.64	10.68	8.85	7.22	4.03	2.10

## Constant Power Discharge (Watts/cell @ 25°C /77°F)

V/cell	10min	15min	20min	25min	30min	35min	40min	45min	50min	55min	1hr	2hr	3hr	4hr	5hr	10hr	20hr
1.60	172.03	131.32	115.57	99.82	87.17	78.49	72.91	67.33	62.25	58.27	54.59	29.54	21.57	18.33	15.10	8.46	4.46
1.65	165.93	126.66	111.70	96.74	84.88	76.41	71.04	65.67	60.80	57.03	53.57	28.92	21.36	18.13	14.89	8.38	4.46
1.70	159.55	121.79	107.55	93.31	82.17	73.98	68.89	63.80	59.22	55.73	52.54	28.21	20.95	17.81	14.67	8.21	4.40
1.75	152.61	116.50	103.05	89.60	79.26	71.35	66.54	61.73	57.42	54.21	51.30	27.28	20.34	17.37	14.40	8.15	4.32
1.80	145.12	110.78	98.20	85.62	76.14	68.51	63.98	59.45	55.42	52.49	49.86	26.29	19.80	16.94	14.08	8.07	4.28

Subject to revision without notice. Please contact our sales representatives for latest version.

Web: [www.generagybattery.com](http://www.generagybattery.com) | Email: [sales@generagybattery.com](mailto:sales@generagybattery.com)

# NM12-40

12V40Ah / 10hr rate



**Graphs**

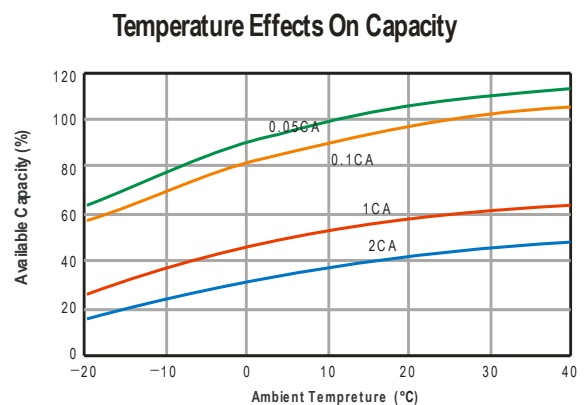
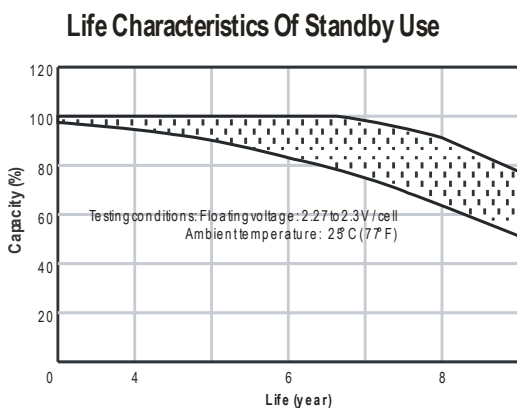
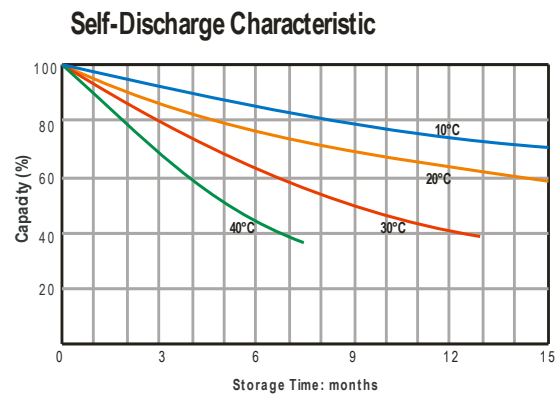
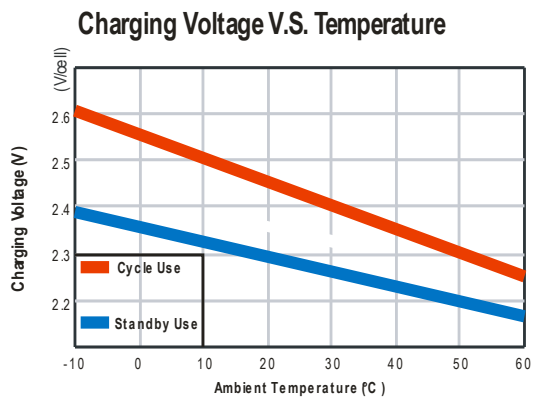
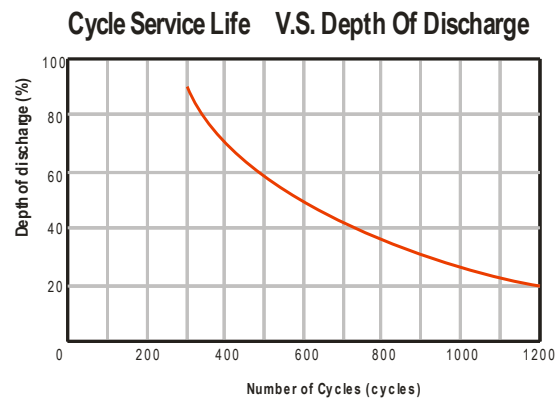
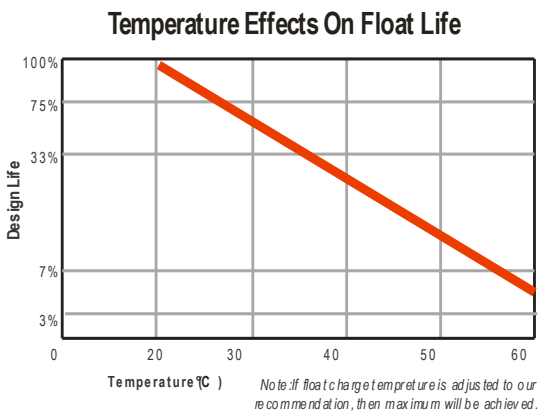
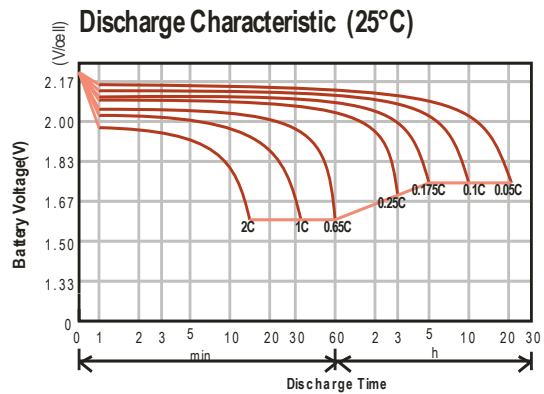
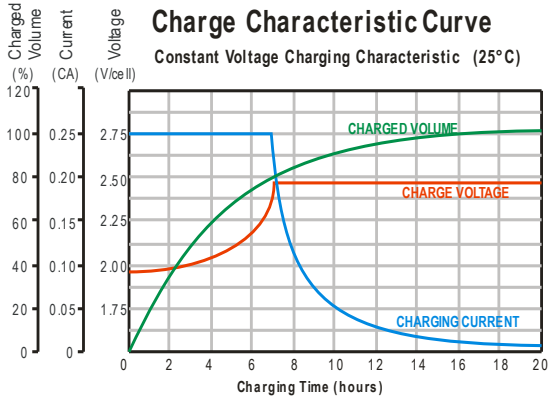

Subject to revision without notice. Please contact our sales representatives for latest version.

Web: [www.genergybattery.com](http://www.genergybattery.com) | Email: [sales@genergybattery.com](mailto:sales@genergybattery.com)