

NS12-26

12V26Ah / 20hr rate



Introduction

Generagy NS UPS (4.5Ah-28Ah) series is designed for standby use with 5-year design life in float service. The series battery is featured of high consistency, excellent performance and reliable standby service life. It is widely applied in UPS/EPS, medical equipment, emergency light and security system.

Battery Features

- Low self-discharge
- Fully tank formed plates
- Low impurity electrolyte
- Spill proof / leak proof
- Multi-position usage
- ABS case and cover VO upon request
- Very high purity lead

Electrical Specification

| | |
|--|--------------|
| Design floating Life @ 25°C (77°F) | 5 years |
| Nominal Capacity @ 25°C /77°F | |
| 20 hour rate 1.30A to 1.75Vpc | 26.0Ah |
| 10 hour rate 2.46A to 1.75Vpc | 24.6 Ah |
| Internal Resistance | |
| (Fully charged battery @ 25°C /77°F) | 11 mΩ |
| Max. Discharge Current @ 25°C /77°F | 390 A (5S) |
| Charge Methods: Constant voltage charge @ 25°C /77°F | |
| Cycle Use | 14.7 ~ 14.9V |
| Max. Current | 6.1 A |
| Standby Use | 13.6 - 13.8V |
| Operating Temperature Range | -30 ~ 50°C |
| <i>Notes: battery voltage must be adjusted according to temperature. Please refer to our recommendation.</i> | |
| Self-Discharge | |
| 3% of capacity declined per month @ 25°C (77°F). | |

Battery Picture & Terminal Layout

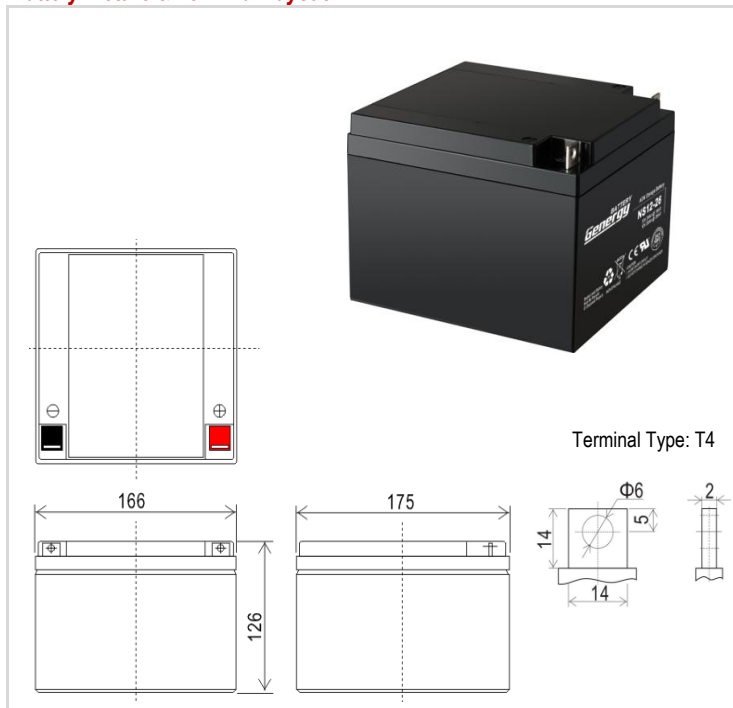

Dimension & Weight

| | Dimension (± 2mm) | | | | Weight (± 2%) |
|--|-------------------|----------|----------|--------------|---------------|
| | Length | Width | Height | Total Height | |
| | 175 mm | 166 mm | 126 mm | 126 mm | 7.75 kg |
| | 6.5 inch | 6.9 inch | 4.9 inch | 4.9 inch | 17.31 lbs |

Typical Applications

- UPS & EPS
- Security Power Supply
- Power Utility
- Electrical Toys

Certificates



Constant Current Discharge (Amperes @ 25°C /77°F)

| V/cell | 10min | 15min | 20min | 25min | 30min | 35min | 40min | 45min | 50min | 55min | 1hr | 2hr | 3hr | 4hr | 5hr | 10hr | 20hr |
|--------|-------|-------|-------|-------|-------|-------|-------|-------|-------|-------|-------|-------|------|------|------|------|------|
| 1.60 | 66.75 | 50.96 | 44.32 | 37.68 | 32.34 | 28.67 | 26.31 | 23.95 | 22.02 | 20.63 | 19.57 | 10.07 | 6.93 | 5.43 | 4.69 | 2.57 | 1.34 |
| 1.65 | 63.93 | 48.80 | 42.49 | 36.18 | 31.17 | 27.64 | 25.40 | 23.17 | 21.37 | 20.11 | 19.18 | 9.85 | 6.77 | 5.32 | 4.62 | 2.53 | 1.34 |
| 1.70 | 61.11 | 46.65 | 40.66 | 34.66 | 29.97 | 26.57 | 24.47 | 22.37 | 20.71 | 19.58 | 18.78 | 9.62 | 6.64 | 5.21 | 4.54 | 2.50 | 1.30 |
| 1.75 | 58.29 | 44.50 | 38.85 | 33.20 | 28.84 | 25.57 | 23.59 | 21.61 | 20.07 | 19.07 | 18.39 | 9.39 | 6.44 | 5.08 | 4.47 | 2.46 | 1.30 |
| 1.80 | 55.47 | 42.34 | 37.06 | 31.78 | 27.80 | 24.63 | 22.76 | 20.89 | 19.46 | 18.57 | 18.00 | 9.16 | 6.25 | 4.94 | 4.40 | 2.42 | 1.27 |

Constant Power Discharge (Watts/cell @ 25°C /77°F)

| V/cell | 10min | 15min | 20min | 25min | 30min | 35min | 40min | 45min | 50min | 55min | 1hr | 2hr | 3hr | 4hr | 5hr | 10hr | 20hr |
|--------|--------|-------|-------|-------|-------|-------|-------|-------|-------|-------|-------|-------|-------|-------|------|------|------|
| 1.60 | 127.86 | 97.61 | 84.47 | 71.33 | 61.33 | 54.24 | 50.30 | 46.35 | 43.16 | 40.84 | 38.84 | 20.28 | 14.02 | 10.91 | 8.57 | 5.21 | 2.83 |
| 1.65 | 122.69 | 93.66 | 81.06 | 68.46 | 59.01 | 52.04 | 48.22 | 44.40 | 41.34 | 39.14 | 37.27 | 19.37 | 13.68 | 10.67 | 8.42 | 5.16 | 2.76 |
| 1.70 | 117.52 | 89.71 | 77.78 | 65.85 | 57.07 | 50.17 | 46.41 | 42.65 | 39.65 | 37.51 | 35.70 | 18.45 | 13.35 | 10.43 | 8.27 | 5.11 | 2.71 |
| 1.75 | 113.29 | 86.48 | 74.85 | 63.23 | 54.74 | 47.96 | 44.33 | 40.70 | 37.82 | 35.82 | 34.13 | 17.54 | 12.98 | 10.17 | 8.12 | 5.05 | 2.70 |
| 1.80 | 108.12 | 82.53 | 71.58 | 60.62 | 52.80 | 46.16 | 42.66 | 39.16 | 36.42 | 34.55 | 33.00 | 16.88 | 12.57 | 9.85 | 7.90 | 4.99 | 2.56 |

Subject to revision without notice. Please contact our sales representatives for latest version.

Web: www.generagybattery.com | Email: sales@generagybattery.com

Version NO.20180807

Page 1 of 2

NS12-26

12V26Ah / 20hr rate



Graphs

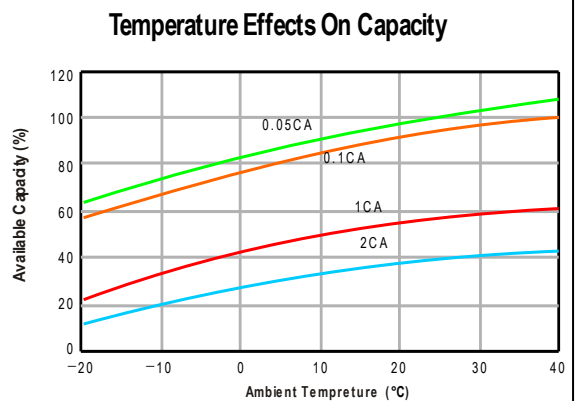
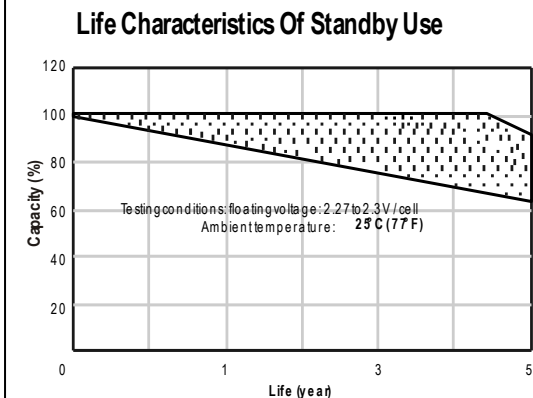
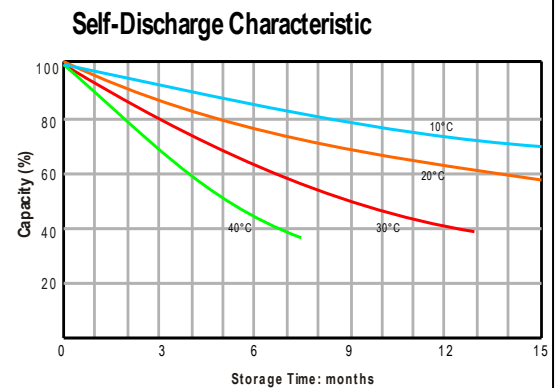
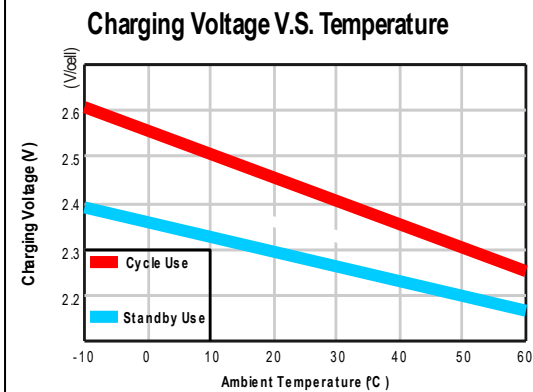
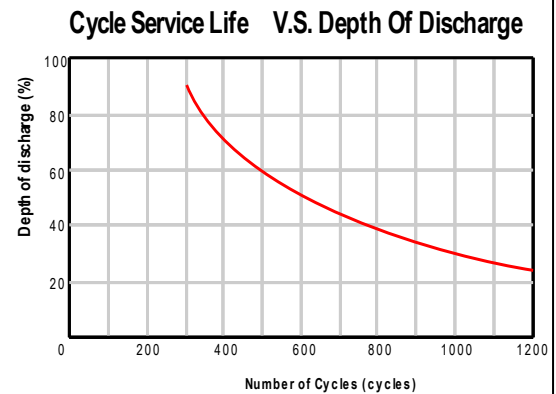
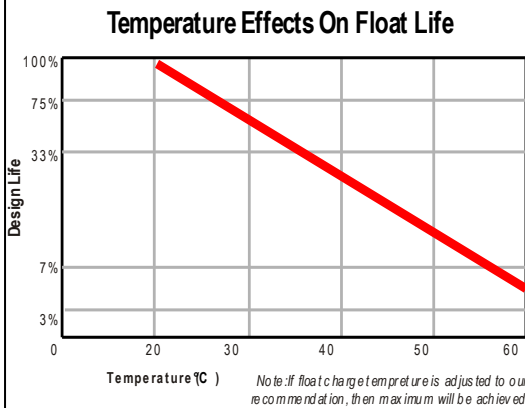
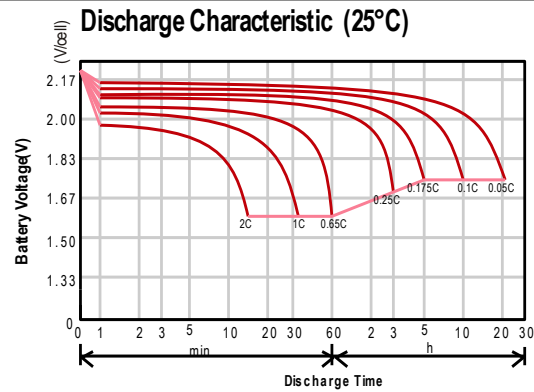
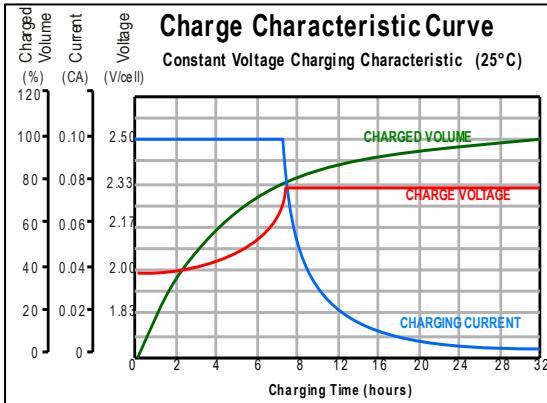

Subject to revision without notice. Please contact our sales representatives for latest version.

Web: www.genergybattery.com | Email: sales@genergybattery.com

Version NO.20180807