

# NFH12-400W

12V400W/ 15min rate



### Introduction

**Generagy NFH (Front Terminal) series** is primarily for heavy load discharge in short time backup especially for telecom UPS/EPs system with 12-year design life in float service. The battery is featured of high consistency, excellent performance and reliable standby service life.

### Battery Features

- Compactness
- ETSI 19 inch / 23 inch integration
- Rackable standard component
- High power to volume ratio
- Modularity
- Long life
- Front connection and terminal access
- Central gassing system and hinged front covers on all models
- Fully tank formed plates
- Low impurity electrolyte
- Multi-position usage
- Spill proof / leak proof
- ABS case and cover VO upon request
- Very high purity lead

### Electrical Specification

Design floating Life @ 25°C (77°F) ..... 12 years

Nominal Capacity @ 25°C /77°F

Watt @ 15min to 1.67V/cell .....400 W/cell

Watt @ 10min to 1.67V/cell .....456 W/cell

Internal Resistance

(Fully charged battery @ 25°C /77°F ) ..... 5mΩ

Max. Discharge Current @ 25°C /77°F ..... 1000 A (5S)

Charge Methods: Constant voltage charge @ 25°C /77°F

Cycle Use ..... 14.7 ~ 14.9V

Max. Current ..... 25 A

Standby Use ..... 13.6 - 13.8V

Operating Temperature Range ..... -30 ~ 50°C

Notes: battery voltage must be adjusted according to temperature.

Please refer to our recommendation.

Self-Discharge

3% of capacity declined per month @ 25°C (77°F).

### Battery Picture & Terminal Layout

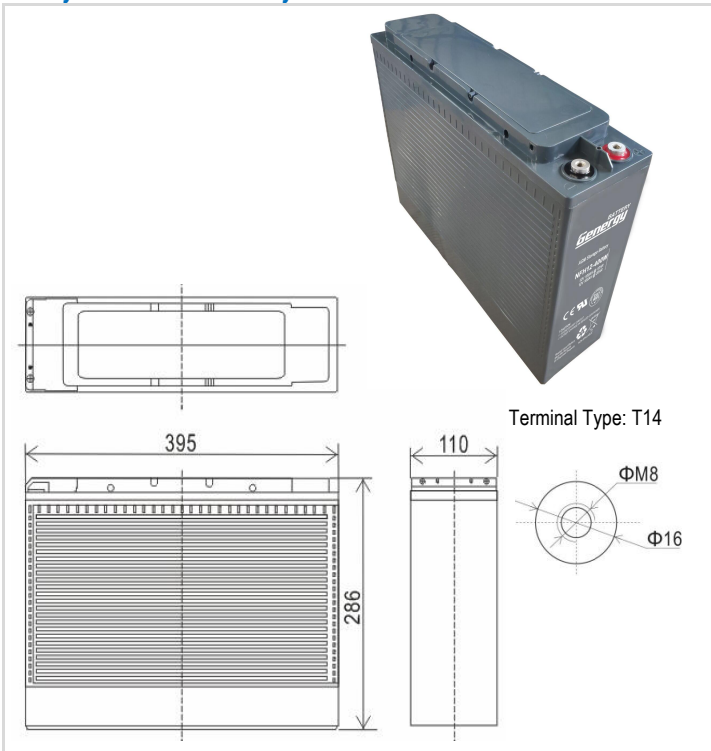

### Dimension & Weight

Length	Dimension (± 2mm)			Total Height	Weight (± 2%)
	Width	Height	Height		
395 mm	110 mm	286 mm	286 mm	286 mm	32.1 kg
15.6 inch	4.3 inch	11.3 inch	11.3 inch	11.3 inch	70.8 lbs

### Typical Applications

- Telecommunications
- Power Utility
- Data Center
- UPS & EPS

### Certificates



### Constant Current Discharge (Amperes @ 25°C /77°F)

V/cell	5min	10min	15min	20min	30min	45min	55min	1hr	2hr
1.60	335.4	234.7	200.5	166.8	122.4	86.9	80.7	70.4	40.3
1.65	321.7	226.1	199.3	163.4	121.1	86.8	78.9	69.6	40.2
1.70	314.4	222.0	196.1	163.1	120.3	86.6	78.6	69.3	39.9
1.75	285.2	212.3	189.9	159.3	119.3	86.4	78.3	69.2	39.5
1.80	255.8	195.6	180.2	152.1	115.8	84.3	75.7	68.2	39.1

### Constant Power Discharge (Watts/cell @ 25°C /77°F)

V/cell	5min	10min	15min	20min	30min	45min	55min	1hr	2hr
1.60	674.1	470.2	405.3	336.6	247.8	177.2	165.3	143.8	82.0
1.65	657.2	466.1	402.0	334.5	246.8	175.8	159.2	143.3	80.1
1.67	643.7	456.3	400.0	328.7	243.0	175.4	156.3	142.5	78.6
1.70	614.8	444.9	394.8	325.9	239.9	172.4	152.6	140.5	76.1
1.75	595.3	429.8	391.5	319.0	238.0	170.8	147.2	137.9	73.5
1.80	526.9	412.2	369.6	310.5	237.2	168.5	145.1	134.6	71.9

Subject to revision without notice. Please contact our sales representatives for latest version.

Web: [www.generagybattery.com](http://www.generagybattery.com) | Email: [sales@generagybattery.com](mailto:sales@generagybattery.com)

# NFH12-400W

12V400W / 15min rate



## Graphs

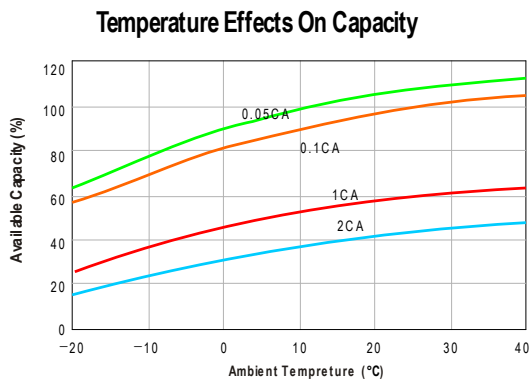
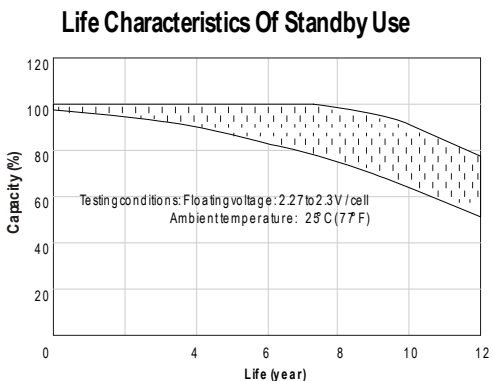
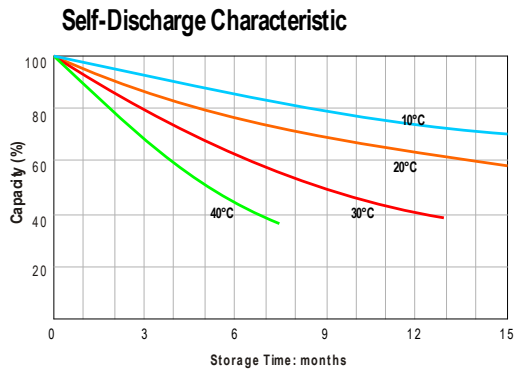
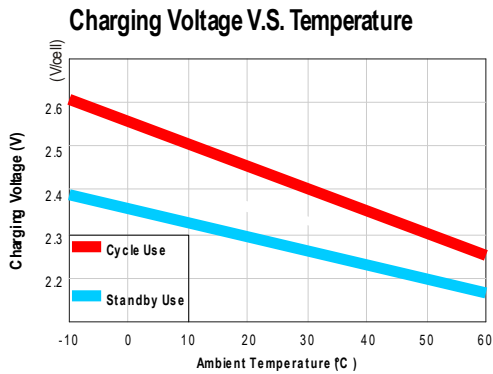
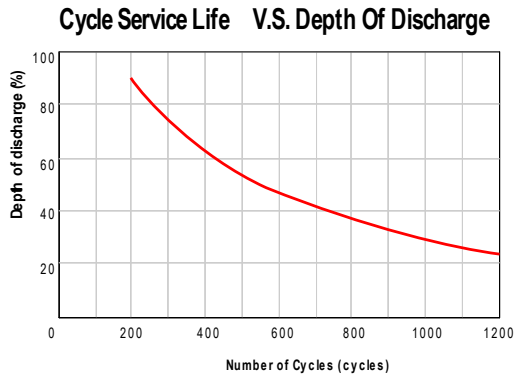
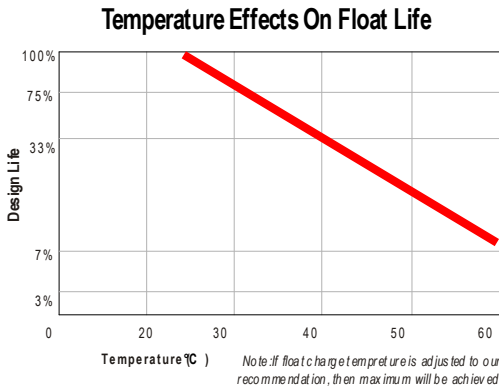
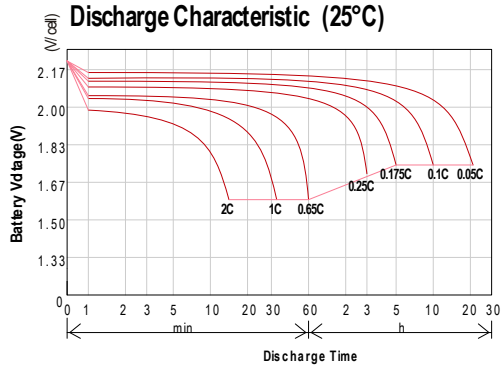
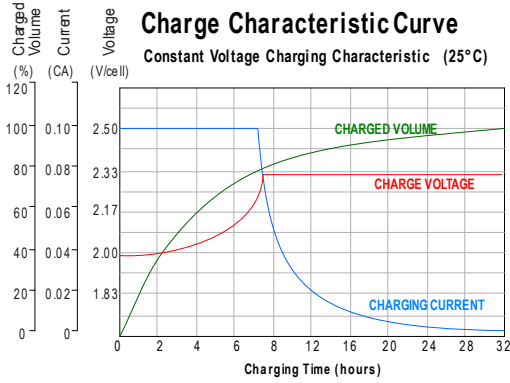

Subject to revision without notice. Please contact our sales representatives for latest version.