

NL2-400

2V400Ah / 10hr rate



Introduction

Genergy NL (2V) series is designed for standby use with 15-year design life in float service. The series battery is featured of high consistency, excellent performance and reliable standby service life. It is widely applied in Telecoms, Power Utility, Renewables, UPS/EPS, and medical equipment.

Key Features

- Valve regulated maximum internal pressure 2.5 PSI
- Increase durability and deep cycle ability for heavy demand applications
- Low self-discharge
- Fully tank formed plates
- Low impurity electrolyte
- Spill proof / leak proof
- Multi-position usage
- ABS case and cover VO upon request
- Very high purity lead

Electrical Specification

Design floating Life @ 25°C (77°F)	15 years
Nominal Capacity @ 25°C /77°F		
20 hour rate	21.52A to 1.75Vpc	430 Ah
10 hour rate	41.03A to 1.75Vpc	410 Ah
Internal Resistance		
(Fully charged battery @ 25°C /77°F)	0.8 mΩ
Max. Discharge Current @ 25°C /77°F	1300 A (5S)
Charge Methods: Constant voltage charge @ 25°C /77°F		
Cycle Use	2.45 ~ 2.49V
Max. Current	80 A
Standby Use	2.25 ~ 2.30V
Operating Temperature Range	-30 ~ 50°C

Notes: battery voltage must be adjusted according to temperature.
Please refer to our recommendation.

Self-Discharge		
		3% of capacity declined per month @ 25°C (77°F).

Battery Picture & Terminal Layout

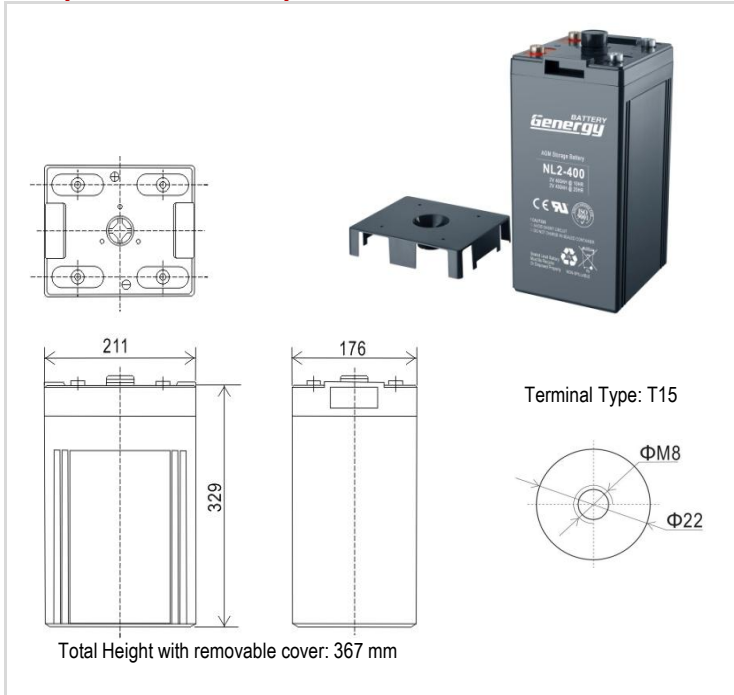

Dimension & Weight

Length	Dimension (± 2mm)			Total Height	Weight (± 2%)
	Width	Height			
211 mm	176 mm	329 mm	367 mm	25.2 kg	
8.3 inch	6.9 inch	13.0 inch	14.4 inch	55.6 lbs	

Typical Applications

- Telecommunications
- Power Utility
- Solar energy system
- UPS & EPS

Certificates



Constant Current Discharge (Amperes @ 25°C /77°F)

V/cell	10min	15min	20min	25min	30min	35min	40min	45min	50min	55min	1hr	2hr	3hr	4hr	5hr	10hr	20hr
1.60	779.8	595.3	535.0	474.7	415.5	386.1	357.8	329.6	305.7	284.1	267.3	149.85	115.48	98.54	83.01	43.05	22.53
1.65	741.1	565.7	509.0	452.2	396.7	368.9	342.4	315.8	293.6	273.7	258.6	144.77	112.11	96.19	81.66	42.38	22.20
1.70	702.3	536.1	483.0	429.8	377.9	351.7	326.7	301.7	281.1	262.7	249.2	139.29	108.75	93.83	80.32	41.70	21.86
1.75	662.6	505.8	456.1	406.3	357.7	333.2	309.9	286.5	267.6	250.9	239.1	133.43	104.04	90.47	78.30	41.03	21.52
1.80	623.0	475.6	429.1	382.7	337.5	314.7	293.0	271.4	254.2	239.1	229.0	127.56	99.33	87.11	76.28	40.36	21.19

Constant Power Discharge (Watts/cell @ 25°C /77°F)

V/cell	10min	15min	20min	25min	30min	35min	40min	45min	50min	55min	1hr	2hr	3hr	4hr	5hr	10hr	20hr
1.60	1254.8	957.8	890.4	822.9	758.5	709.1	662.8	616.5	572.9	535.0	507.6	292.2	228.5	196.1	158.3	86.10	45.07
1.65	1210.7	924.2	855.4	786.5	720.8	674.3	630.9	587.6	546.9	511.9	487.4	280.4	222.5	192.0	156.3	84.75	44.39
1.70	1118.2	853.6	795.3	737.0	681.8	638.3	598.0	557.6	520.0	488.0	466.5	268.3	216.4	187.7	153.6	83.41	43.72
1.75	1049.5	801.1	747.3	693.5	642.8	602.2	564.8	527.4	492.6	463.6	445.0	255.8	209.7	183.0	150.9	82.06	43.05
1.80	979.9	748.0	698.7	649.3	603.1	565.4	530.7	496.1	464.1	437.9	422.2	242.5	195.5	174.9	148.9	80.72	42.38

Subject to revision without notice. Please contact our sales representatives for latest version.

Web: www.genergybattery.com | Email: sales@genergybattery.com

Version NO.20190618

Page 1 of 2

NL2-400

2V400Ah / 10hr rate



Graphs

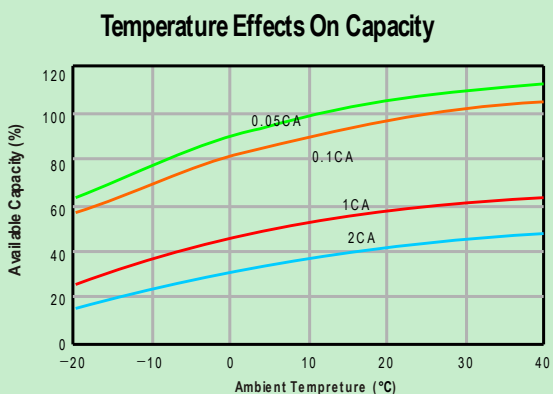
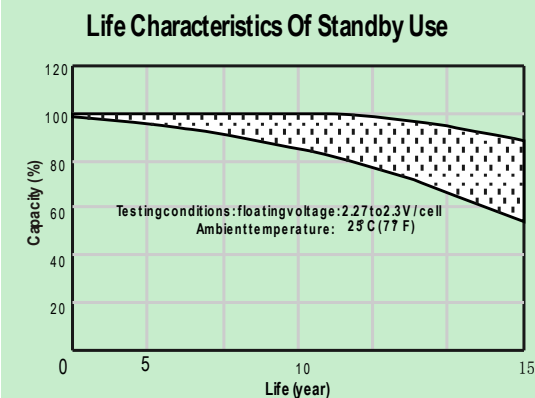
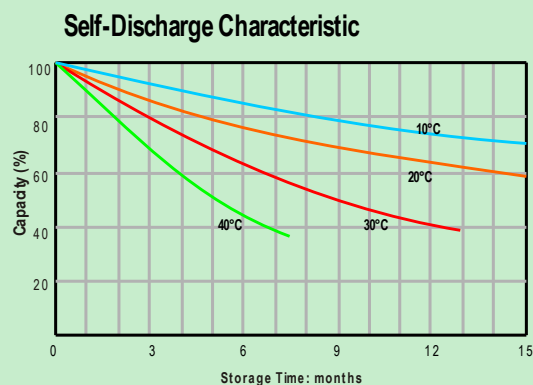
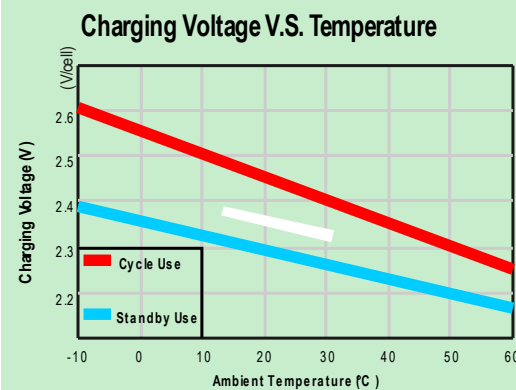
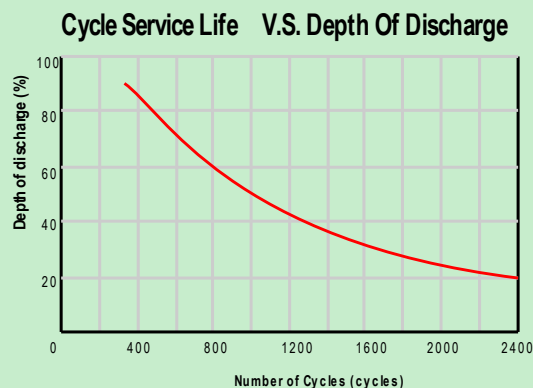
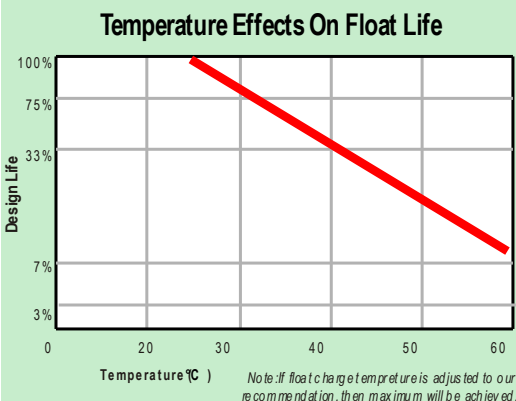
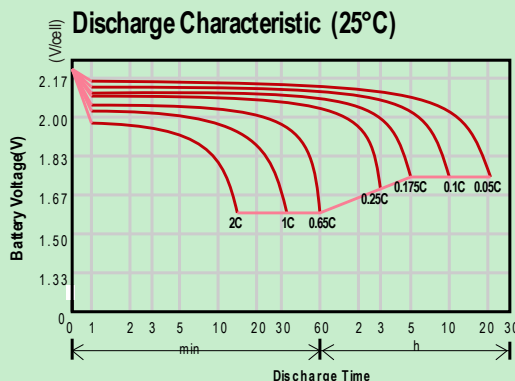
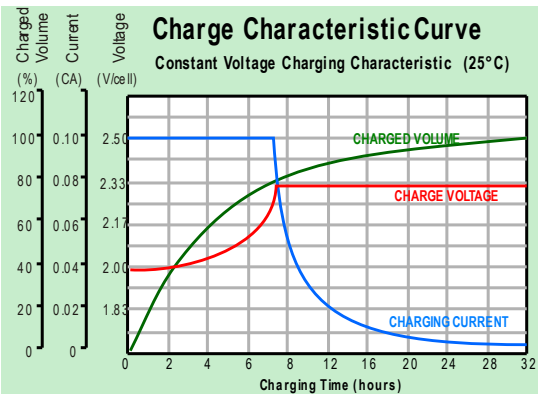

Subject to revision without notice. Please contact our sales representatives for latest version.