

NL2-500

2V500Ah / 10hr rate



Introduction

Genergy NL (2V) series is designed for standby use with 15-year design life in float service. The series battery is featured of high consistency, excellent performance and reliable standby service life. It is widely applied in Telecoms, Power Utility, Renewables, UPS/EPS, and medical equipment.

Key Features

- Valve regulated maximum internal pressure 2.5 PSI
- Increase durability and deep cycle ability for heavy demand applications
- Low self-discharge
- Fully tank formed plates
- Low impurity electrolyte
- Spill proof / leak proof
- Multi-position usage
- ABS case and cover VO upon request
- Very high purity lead

Electrical Specification

| | |
|--|--------------|
| Design floating Life @ 25°C (77°F) | 15 years |
| Nominal Capacity @ 25°C /77°F | |
| 20 hour rate 26.91A to 1.75Vpc | 538 Ah |
| 10 hour rate 51.29A to 1.75Vpc | 512.9Ah |
| Internal Resistance | |
| (Fully charged battery @ 25°C /77°F) | 0.7 mΩ |
| Max. Discharge Current @ 25°C /77°F | 1600 A (5S) |
| Charge Methods: Constant voltage charge @ 25°C /77°F | |
| Cycle Use | 2.45 ~ 2.49V |
| Max. Current | 100 A |
| Standby Use | 2.25 ~ 2.30V |
| Operating Temperature Range | -30 ~ 50°C |

Notes: battery voltage must be adjusted according to temperature. Please refer to our recommendation.

| | |
|----------------|--|
| Self-Discharge | 3% of capacity declined per month @ 25°C (77°F). |
|----------------|--|

Battery Picture & Terminal Layout

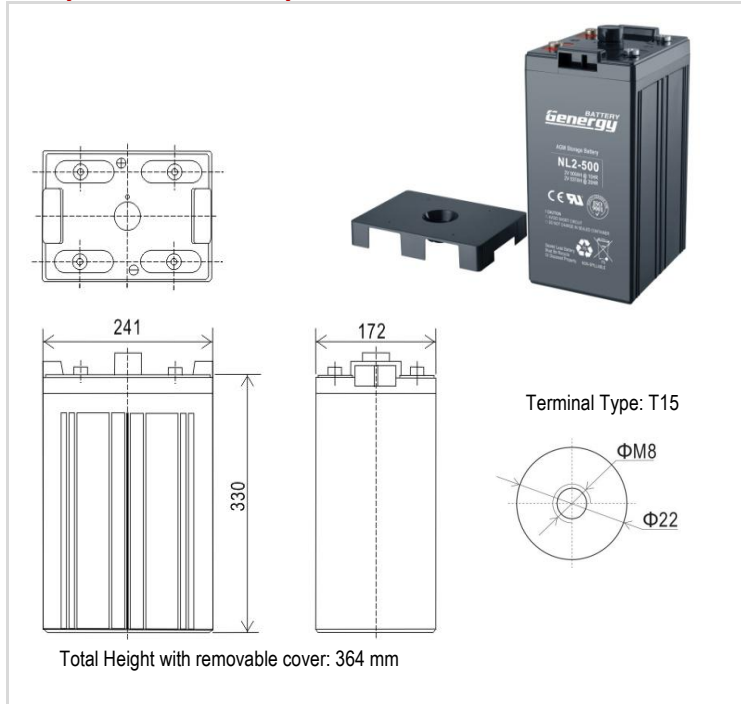

Dimension & Weight

| Length | Dimension (± 2mm) | | | Total Height | Weight (± 2%) |
|----------|-------------------|-----------|--------------|--------------|---------------|
| | Width | Height | Total Height | | |
| 241 mm | 172 mm | 330 mm | 364 mm | 31.6 kg | |
| 9.5 inch | 6.8 inch | 13.0 inch | 14.3 inch | 69.7 lbs | |

Typical Applications

- Telecommunications
- Power Utility
- Solar energy system
- UPS & EPS

Certificates



Constant Current Discharge (Amperes @ 25°C /77°F)

| V/cell | 10min | 15min | 20min | 25min | 30min | 35min | 40min | 45min | 50min | 55min | 1hr | 2hr | 3hr | 4hr | 5hr | 10hr | 20hr |
|--------|-------|-------|-------|-------|-------|-------|-------|-------|-------|-------|-------|-------|-------|-------|-------|-------|-------|
| 1.60 | 974.8 | 744.1 | 668.7 | 593.3 | 524.1 | 482.6 | 447.3 | 412.0 | 385.1 | 362.4 | 343.6 | 198.4 | 147.7 | 123.2 | 102.0 | 53.81 | 28.17 |
| 1.65 | 926.3 | 707.1 | 636.2 | 565.3 | 500.6 | 461.2 | 428.0 | 394.8 | 369.9 | 349.3 | 332.6 | 192.1 | 143.5 | 120.2 | 100.3 | 52.97 | 27.75 |
| 1.70 | 877.9 | 670.1 | 603.7 | 537.3 | 477.1 | 439.6 | 408.4 | 377.1 | 354.3 | 335.6 | 320.9 | 185.2 | 139.3 | 117.3 | 98.6 | 52.13 | 27.33 |
| 1.75 | 828.3 | 632.3 | 570.1 | 507.8 | 451.8 | 416.5 | 387.3 | 358.2 | 337.4 | 320.9 | 308.2 | 177.9 | 133.5 | 113.1 | 96.1 | 51.29 | 26.91 |
| 1.80 | 778.7 | 594.4 | 536.4 | 478.4 | 426.6 | 393.4 | 366.3 | 339.3 | 320.6 | 306.2 | 295.6 | 170.6 | 127.6 | 108.9 | 93.6 | 50.45 | 26.49 |

Constant Power Discharge (Watts/cell @ 25°C /77°F)

| V/cell | 10min | 15min | 20min | 25min | 30min | 35min | 40min | 45min | 50min | 55min | 1hr | 2hr | 3hr | 4hr | 5hr | 10hr | 20hr |
|--------|--------|--------|--------|--------|-------|-------|-------|-------|-------|-------|-------|-------|-------|-------|-------|-------|-------|
| 1.60 | 1568.5 | 1197.3 | 1112.9 | 1028.6 | 939.1 | 886.3 | 828.5 | 770.6 | 715.4 | 672.9 | 637.0 | 365.6 | 284.7 | 245.1 | 200.2 | 107.6 | 56.33 |
| 1.65 | 1513.4 | 1155.3 | 1069.2 | 983.2 | 892.0 | 842.9 | 788.7 | 734.4 | 682.9 | 644.1 | 611.7 | 350.9 | 277.1 | 240.0 | 197.7 | 105.9 | 55.49 |
| 1.70 | 1397.7 | 1067.0 | 994.1 | 921.2 | 843.3 | 797.9 | 747.5 | 697.0 | 649.3 | 614.2 | 585.7 | 335.8 | 269.6 | 234.6 | 194.3 | 104.3 | 54.65 |
| 1.75 | 1311.8 | 1001.4 | 934.1 | 866.9 | 794.5 | 752.8 | 706.0 | 659.2 | 615.1 | 583.7 | 558.8 | 320.1 | 261.2 | 228.7 | 190.9 | 102.6 | 53.81 |
| 1.80 | 1224.8 | 935.0 | 873.3 | 811.7 | 744.9 | 706.7 | 663.4 | 620.1 | 579.5 | 551.6 | 530.2 | 303.5 | 243.5 | 218.6 | 188.4 | 100.9 | 52.97 |

Subject to revision without notice. Please contact our sales representatives for latest version.

Web: www.genergybattery.com | Email: sales@genergybattery.com

NL2-500

2V500Ah / 10hr rate



Graphs

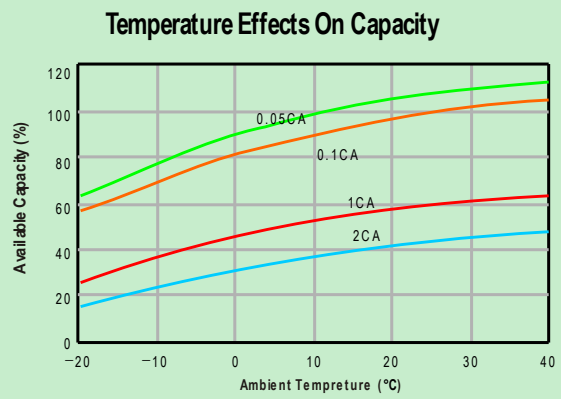
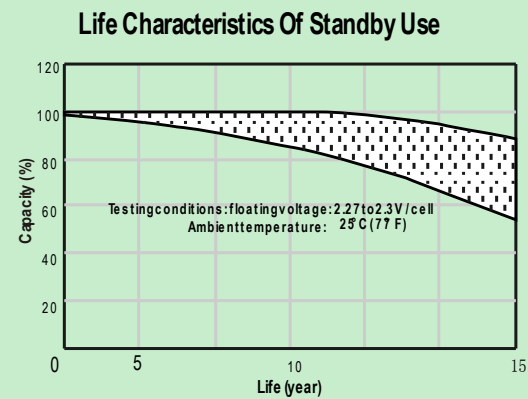
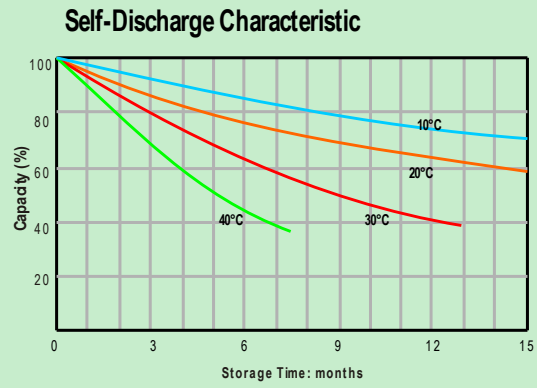
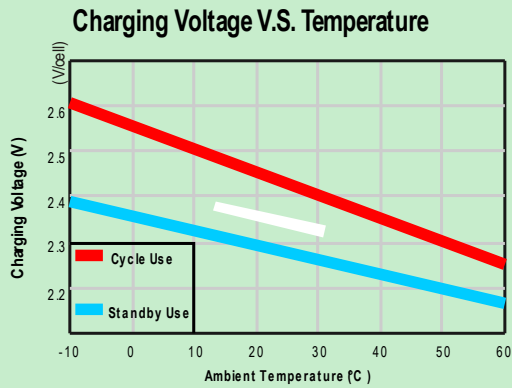
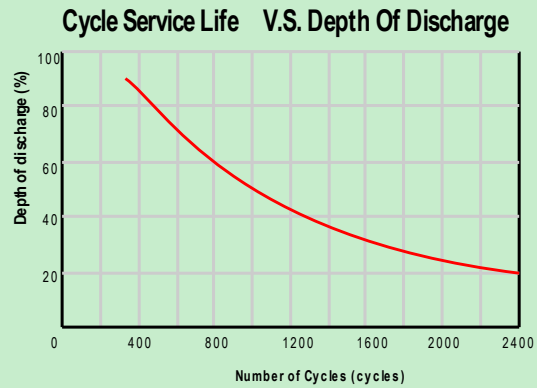
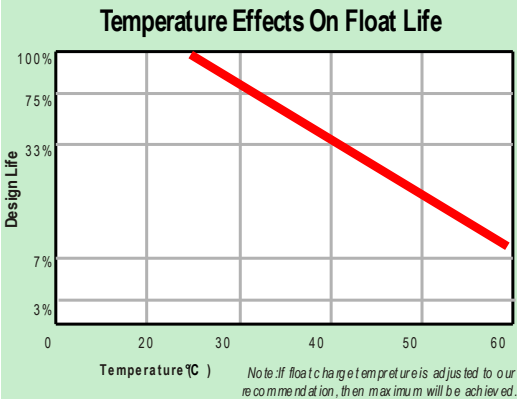
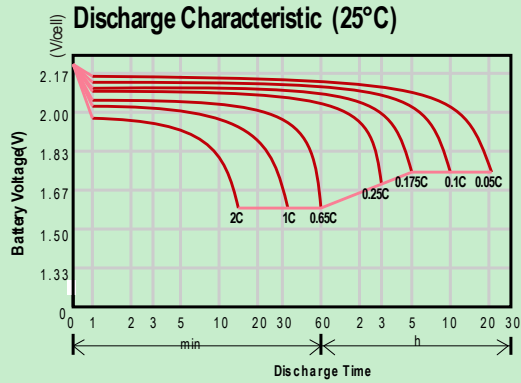
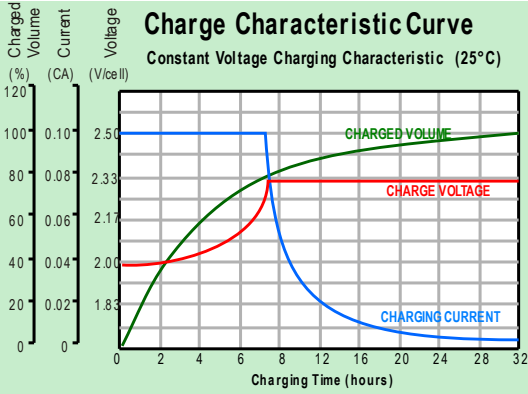

Subject to revision without notice. Please contact our sales representatives for latest version.