

# EB12-230

12V230Ah / 10hr rate



### Introduction

**Generagy EB series** is designed for European standard with 12-year design life in float service. The series battery is featured of high consistency, excellent performance and reliable standby service life. It is widely applied in float service, UPS/EPS, medical equipment, telecom, photovoltaic, control system and security system.

### Battery Features

- Increase durability and deep cycle ability for heavy demand applications
- Low self-discharge
- Fully tank formed plates
- Low impurity electrolyte
- Spill proof / leak proof
- Multi-position usage
- ABS case and cover VO upon request
- Very high purity lead

### Electrical Specification

Design floating Life @ 20°C (68°F)	12 years
Nominal Capacity @ 20°C (68°F)	
20 hour rate 12.01A to 1.75Vpc	240.2 Ah
10 hour rate 23A to 1.80Vpc	230 Ah

#### Internal Resistance

(Fully charged battery @ 20°C (68°F)) ..... 3.5 mΩ

Max. Discharge Current @ 20°C (68°F) ..... 2300 A (5S)

#### Charge Methods: Constant voltage charge @ 20°C (68°F)

Cycle Use ..... 14.7 ~ 14.9V

Max. Current ..... 53 A

Standby Use ..... 13.6 - 13.8V

Operating Temperature Range ..... -30 ~ 50°C

Notes: battery voltage must be adjusted according to temperature.

Please refer to our recommendation.

#### Self-Discharge

3% of capacity declined per month @ 20°C (68°F).

### Battery Picture & Terminal Layout

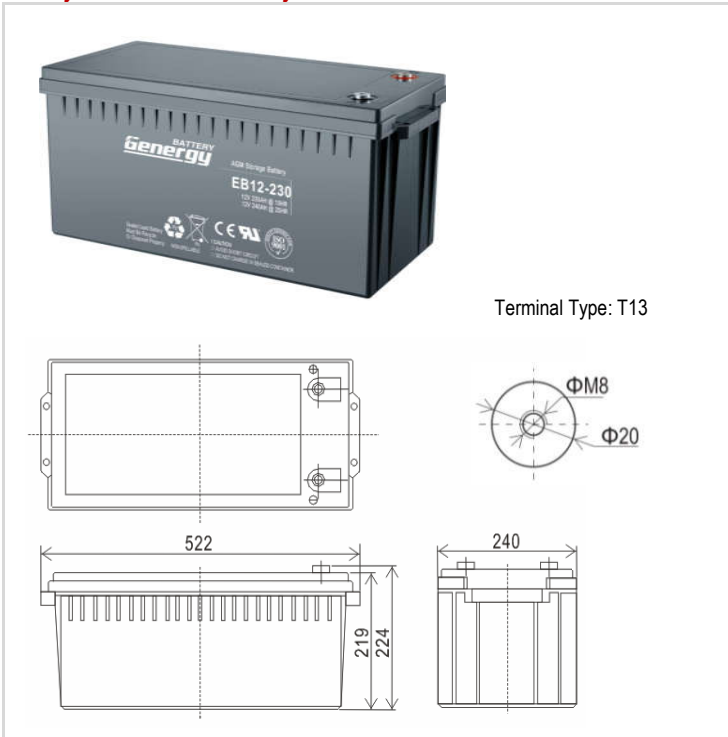

### Dimension & Weight

Length	Dimension (± 2mm)			Total Height	Weight (± 2%)
	Width	Height	Height		
522 mm	240 mm	219 mm	224 mm	64.5 kg	
20.6 inch	9.4 inch	8.6 inch	8.8 inch	142.2 lbs	

### Typical Applications

- UPS & EPS
- Telecommunications
- Power Utility
- Security Power Supply

### Certificates



### Constant Current Discharge (Amperes @ 20°C (68°F))

V/cell	10min	15min	20min	25min	30min	35min	40min	45min	50min	55min	1hr	2hr	3hr	4hr	5hr	10hr	20hr
1.60	488.4	372.8	322.1	271.3	229.7	224.9	209.7	195.8	183.1	172.1	171.5	92.96	66.15	54.94	44.92	24.00	12.12
1.65	463.8	354.0	307.5	261.0	223.5	218.9	204.5	191.3	179.4	169.1	169.1	91.16	64.88	53.78	43.88	23.88	12.10
1.70	444.6	339.4	295.4	251.3	216.3	211.7	197.8	185.2	173.8	164.1	164.5	88.09	63.38	52.52	42.84	23.65	12.07
1.75	424.1	323.8	282.2	240.6	208.1	203.7	190.8	179.0	168.6	159.8	161.0	85.65	62.00	51.37	41.92	23.42	12.01
1.80	402.2	307.0	268.3	229.6	199.9	195.5	183.3	172.3	162.6	154.6	156.3	82.57	60.50	50.10	40.88	23.00	11.89

### Constant Power Discharge (Watts/cell @ 20°C (68°F))

V/cell	10min	15min	20min	25min	30min	35min	40min	45min	50min	55min	1hr	2hr	3hr	4hr	5hr	10hr	20hr
1.60	848.2	647.5	569.8	492.2	429.0	421.2	391.2	363.7	338.1	316.5	312.6	171.8	125.1	103.8	85.46	47.88	25.26
1.65	818.1	624.5	550.8	477.0	417.7	410.0	381.2	354.7	330.3	309.8	306.8	168.4	123.9	102.6	84.30	47.42	25.26
1.70	786.7	600.5	530.3	460.1	404.4	397.0	369.7	344.7	321.7	302.8	301.0	164.3	121.6	100.8	83.04	46.50	24.92
1.75	752.5	574.4	508.1	441.8	390.0	382.9	357.1	333.5	312.0	294.6	294.0	159.1	118.1	98.4	81.54	46.15	24.47
1.80	715.5	546.2	484.2	422.2	374.6	367.6	343.3	321.1	301.2	285.3	285.8	153.4	115.0	95.9	79.70	45.69	24.24

Subject to revision without notice. Please contact our sales representatives for latest version.

Web: [www.generagybattery.com](http://www.generagybattery.com) | Email: [sales@generagybattery.com](mailto:sales@generagybattery.com)

# EB12-230

12V230Ah / 10hr rate



Graphs

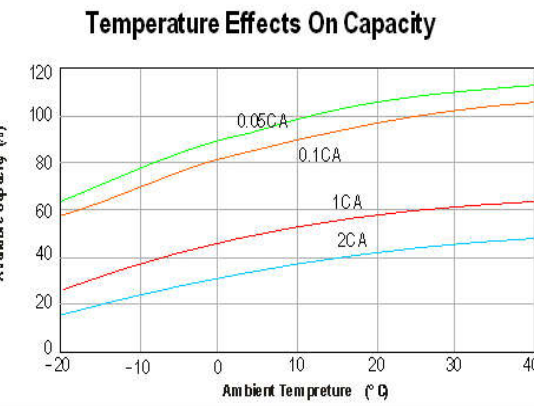
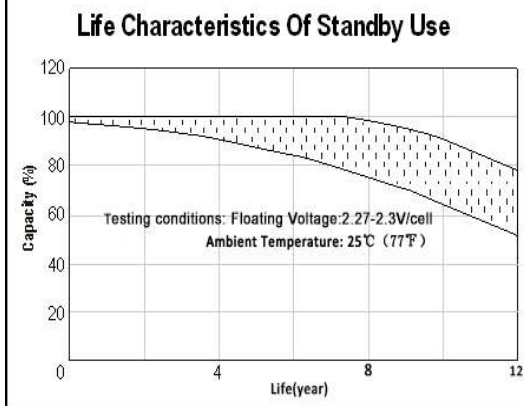
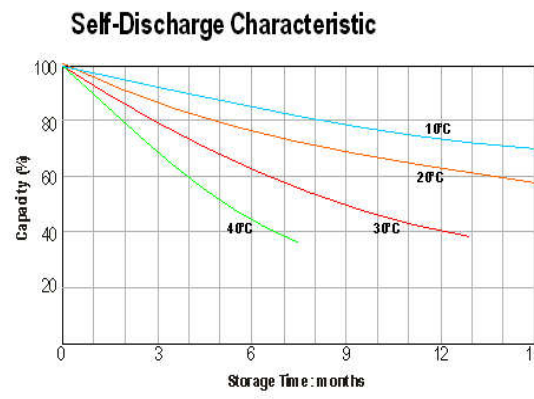
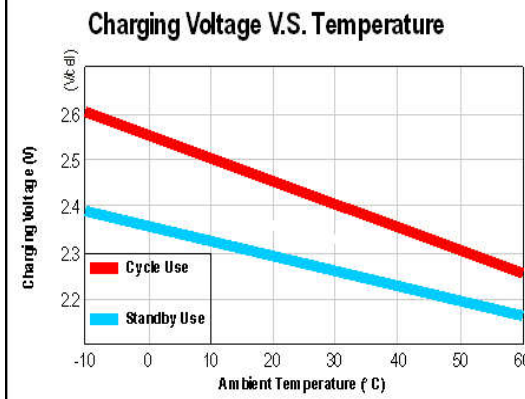
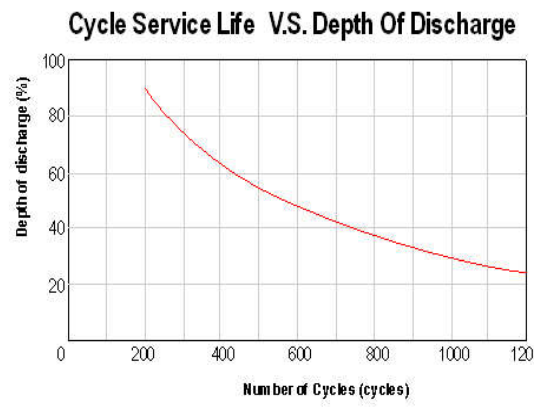
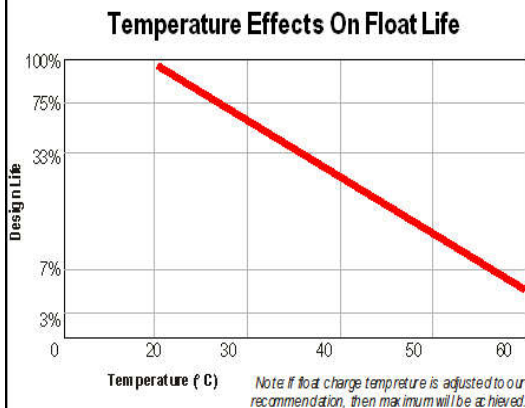
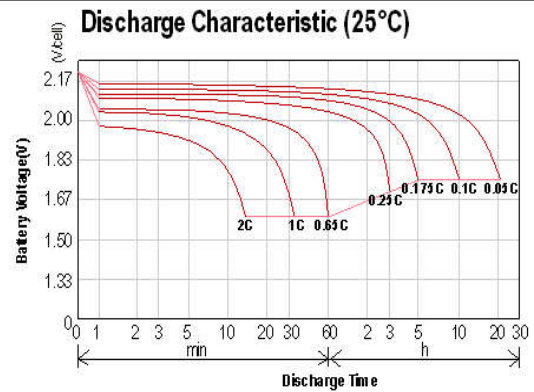
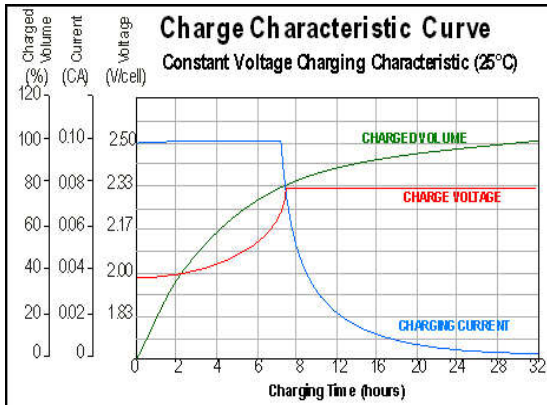

Subject to revision without notice. Please contact our sales representatives for latest version.