

EB12-24

12V24Ah / 10hr rate



Introduction

Genergy EB series is designed for European standard with 5-year design life in float service. The series battery is featured of high consistency, excellent performance and reliable standby service life. It is widely applied in UPS/EPS, medical equipment, emergency light and security system.

Battery Features

- Low self-discharge
- Fully tank formed plates
- Low impurity electrolyte
- Spill proof / leak proof
- Multi-position usage
- ABS case and cover VO upon request
- very high purity lead

Electrical Specification

Design floating Life @ 20°C (68°F)	5 years
Nominal Capacity @ 20°C /68°F	
20 hour rate 1.29A to 1.75Vpc	25.8 Ah
10 hour rate 2.4A to 1.80Vpc	24 Ah
Internal Resistance	
(Fully charged battery @ 20°C /68°F)	11mΩ
Max. Discharge Current @ 20°C /68°F	420A (5S)
Charge Methods: Constant voltage charge @ 20°C /68°F	
Cycle Use	14.7 ~ 14.9V
Max. Current	6 A
Standby Use	13.6 - 13.8V
Operating Temperature Range	-30 ~ 50°C
<i>Notes: battery voltage must be adjusted according to temperature. Please refer to our recommendation.</i>	
Self-Discharge	
3% of capacity declined per month @ 20°C (68°F).	

Battery Picture & Terminal Layout

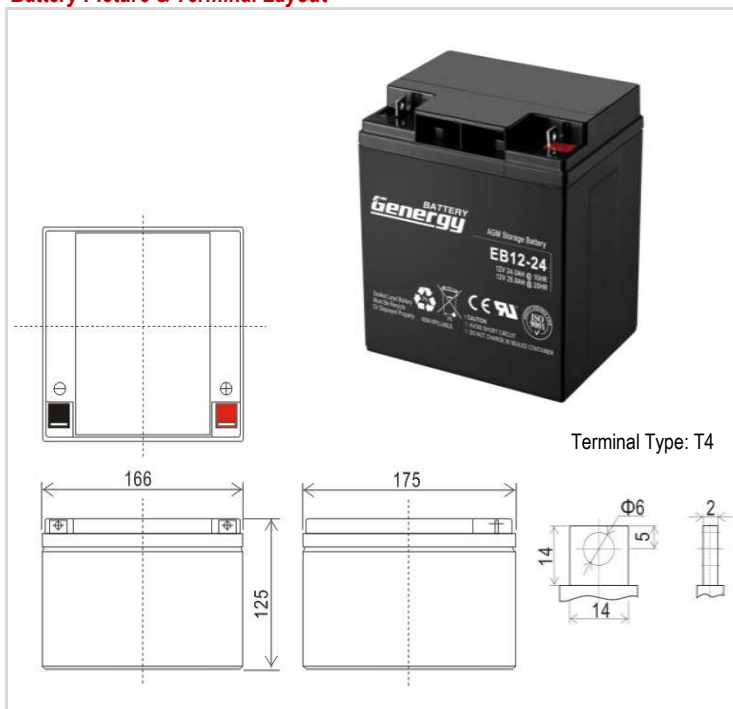

Dimension & Weight

Length	Dimension (± 2mm)			Total Height	Weight (± 2%)
	Width	Height			
166 mm	175 mm	125 mm	125 mm	7.8 kg	
6.5 inch	6.9 inch	4.9 inch	4.9 inch	17.2 lbs	



Constant Current Discharge (Amperes @ 20°C /68°F)

V/cell	10min	15min	20min	25min	30min	35min	40min	45min	50min	55min	1hr	2hr	3hr	4hr	5hr	10hr	20hr
1.60	66.28	50.60	44.01	37.41	32.11	28.47	26.13	23.78	21.86	20.49	19.43	10.00	6.89	5.40	4.66	2.55	1.33
1.65	63.48	48.46	42.19	35.93	30.95	27.44	25.23	23.01	21.22	19.97	19.04	9.78	6.72	5.28	4.59	2.52	1.33
1.70	60.68	46.32	40.37	34.42	29.76	26.38	24.30	22.22	20.56	19.45	18.65	9.55	6.59	5.18	4.51	2.48	1.29
1.75	57.88	44.19	38.57	32.96	28.64	25.39	23.43	21.46	19.93	18.94	18.26	9.32	6.40	5.04	4.44	2.44	1.29
1.80	55.08	42.05	36.80	31.56	27.60	24.46	22.60	20.75	19.32	18.44	17.87	9.10	6.20	4.91	4.36	2.40	1.26

Constant Power Discharge (Watts/cell @ 20°C /68°F)

V/cell	10min	15min	20min	25min	30min	35min	40min	45min	50min	55min	1hr	2hr	3hr	4hr	5hr	10hr	20hr
1.60	126.97	96.92	83.88	70.83	60.90	53.86	49.94	46.02	42.86	40.55	38.57	20.14	13.92	10.84	8.51	5.18	2.81
1.65	121.83	93.00	80.49	67.98	58.59	51.68	47.88	44.09	41.05	38.87	37.01	19.23	13.59	10.60	8.36	5.13	2.74
1.70	116.70	89.08	77.24	65.39	56.67	49.81	46.08	42.35	39.37	37.25	35.45	18.32	13.26	10.36	8.21	5.07	2.69
1.75	112.50	85.88	74.33	62.78	54.36	47.63	44.02	40.41	37.56	35.56	33.89	17.42	12.89	10.10	8.06	5.01	2.68
1.80	107.36	81.96	71.07	60.19	52.43	45.83	42.36	38.89	36.16	34.30	32.76	16.76	12.48	9.78	7.84	4.95	2.54

Subject to revision without notice. Please contact our sales representatives for latest version.

Web: www.genergybattery.com | Email: sales@genergybattery.com

EB12-24

12V24Ah / 10hr rate



Graphs

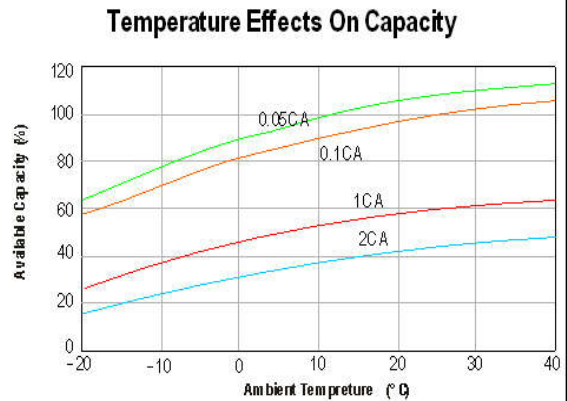
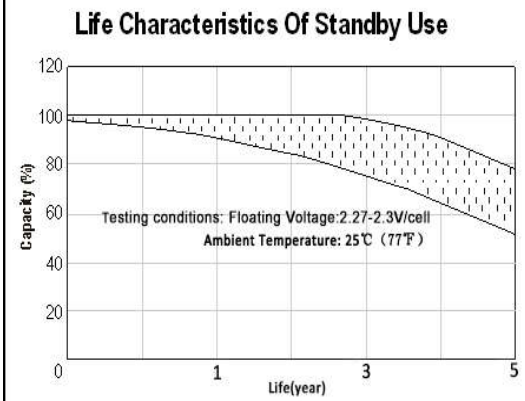
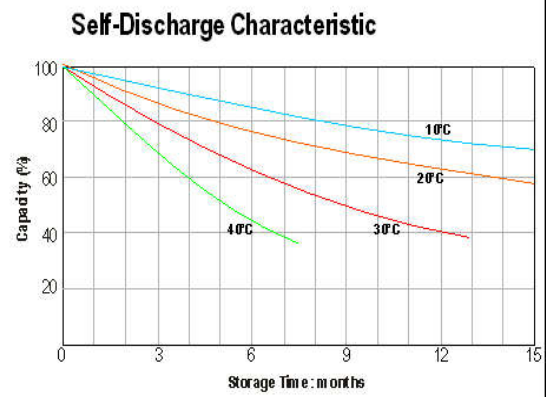
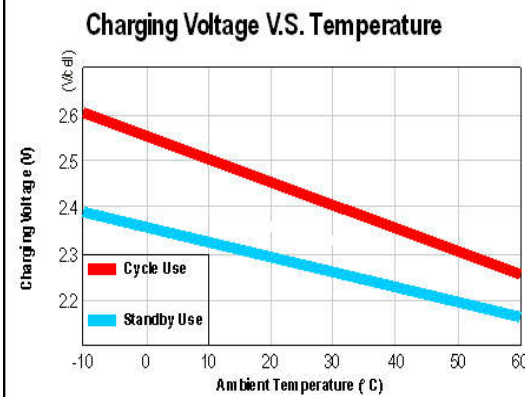
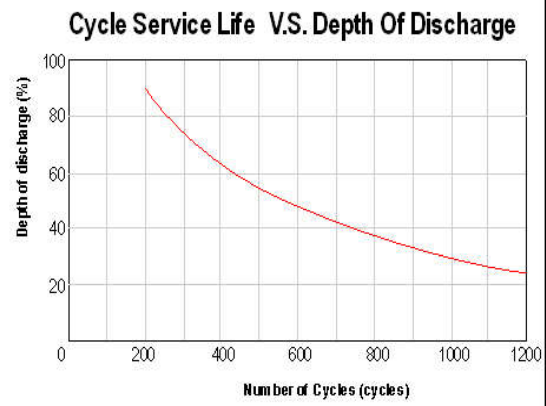
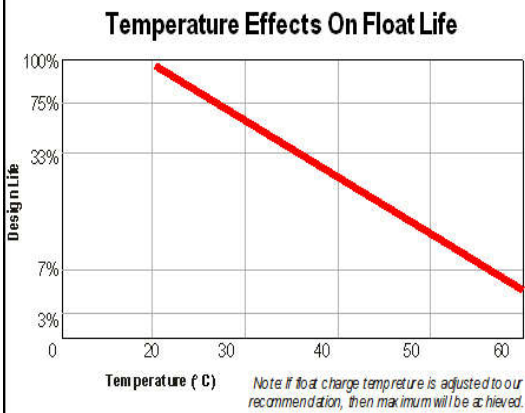
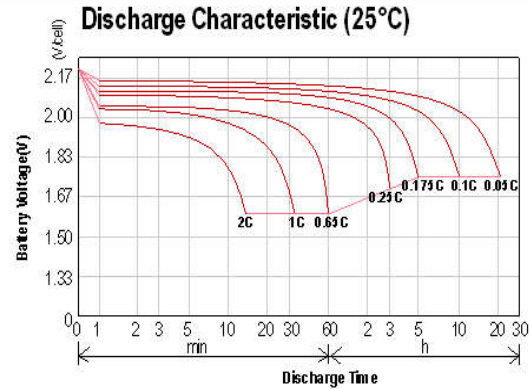
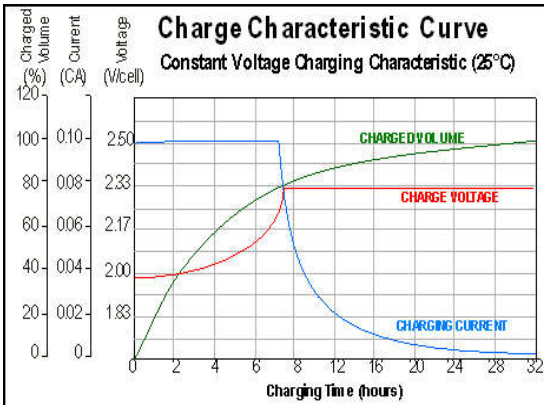

Subject to revision without notice. Please contact our sales representatives for latest version.